

**EN 62040-2:2006**  
**EN 61000-3-2:2014**  
**EN 61000-3-3:2013**  
**Test Report**  
**For**

**Magnizon Power Systems FZE**

JAFZA LB11, 1st floor, Office 32, Jebel Ali Free Zone, Dubai- U.A.E,  
PO Box no: 263819

Product Name:	<b>HG Series Inverters</b>
Model/Type No.:	<b>HG1012-PV, HG1212-PV, HG2024-PV</b>
Prepared By:	<b>Shenzhen Hongcai Testing Technology Co., Ltd.</b> 1st-3rd Floor, Building C, Shuanghuan Xin Yi Dai Hi-Tech Industrial Park, No.8 Baoqing Road, Baolong Industrial Zone, Longgang District, Shenzhen, Guangdong, China Tel: 86-755-86337020 Fax: 86-755-86337028
Report Number:	HCT17JR-1604E
Tested Date:	September 28~ October 02, 2017
Issued Date:	October 02, 2017
Tested By:	Tracy Cai <i>Tracy Cai</i>



Reviewed By:

*Owen Yang*

Owen Yang  
EMC Technical Supervisor

Approved By:

*Tony Wu*

Tony Wu  
EMC Technical Manager

Note: This test report is limited to the above client company and the product model only. It may not be duplicated without prior written consent of Shenzhen Hongcai Testing Technology Co., Ltd.

## TABLE OF CONTENTS

<b>1- GENERAL INFORMATION .....</b>	<b>5</b>
1.1 PRODUCT DESCRIPTION FOR EQUIPMENT UNDER TEST (EUT).....	5
1.2 TEST STANDARDS.....	6
1.3 TEST SUMMARY .....	6
1.4 TEST METHODOLOGY.....	7
1.5 TEST FACILITY.....	7
<b>2- SYSTEM TEST CONFIGURATION .....</b>	<b>8</b>
2.1 JUSTIFICATION.....	8
2.2 EUT EXERCISE SOFTWARE .....	8
2.3 EQUIPMENT MODIFICATIONS .....	8
2.4 BASIC CONFIGURATION OF TEST SYSTEM.....	8
<b>3- CONDUCTED DISTURBANCE AT THE MAINS TERMINALS.....</b>	<b>9</b>
3.1 MEASUREMENT UNCERTAINTY.....	9
3.2 LIMIT OF CONDUCTED DISTURBANCE AT THE MAINS TERMINALS .....	9
3.3 EUT SETUP .....	9
3.4 INSTRUMENT SETUP .....	10
3.5 TEST PROCEDURE .....	10
3.6 TEST EQUIPMENT LIST AND DETAILS.....	11
3.7 TEST DATA.....	11
<b>4- RADIATED DISTURBANCES .....</b>	<b>14</b>
4.1 MEASUREMENT UNCERTAINTY.....	14
4.2 LIMIT OF RADIATED DISTURBANCES .....	14
4.3 EUT SETUP .....	15
4.4 TEST RECEIVER SETUP .....	16
4.5 TEST PROCEDURE .....	16
4.6 CORRECTED AMPLITUDE & MARGIN CALCULATION .....	16
4.7 TEST DATA.....	17
4.8 TEST EQUIPMENT LIST AND DETAILS.....	17
<b>5- HARMONIC CURRENT TEST .....</b>	<b>20</b>
5.1 APPLICATION OF HARMONIC CURRENT EMISSION .....	20
5.2 BLOCK DIAGRAM OF TEST SETUP: .....	20
5.3 TEST PROCEDURE: .....	20
5.4 TEST EQUIPMENT LIST AND DETAILS.....	21
5.5 TEST RESULT .....	21
<b>6- VOLTAGE FLUCTUATIONS AND FLICKER TEST.....</b>	<b>25</b>
6.1 APPLICATION AND LIMIT OF VOLTAGE FLUCTUATIONS AND FLICKER TEST .....	25
6.2 BLOCK DIAGRAM OF TEST SETUP: .....	25
6.3 TEST PROCEDURE: .....	25
6.4 TEST EQUIPMENT LIST AND DETAILS.....	26
6.5 TEST RESULT .....	26
<b>7- IMMUNITY TEST DESCRIPTION .....</b>	<b>27</b>
7.1 GENERAL DESCRIPTION.....	27
7.2 THE PHENOMENA ALLOWED DURING AND AFTER TEST IN EACH CRITERION ARE CLEARLY STATED IN THE FOLLOWING TABLE ...	28
7.3 DEVIATIONS FROM THE STANDARD .....	28
<b>8- IMMUNITY TEST RESULTS.....</b>	<b>29</b>
8.1 ELECTROSTATIC DISCHARGE IMMUNITY TEST .....	29
8.1.1 TEST SPECIFICATION.....	29
8.1.2 TEST SETUP.....	29

8.1.3 TEST PROCEDURE .....	30
8.1.4 TEST EQUIPMENT LIST AND DETAILS .....	30
8.1.5 PERFORMANCE CRITERION REQUIRED & TEST RESULT .....	31
8.2 RADIATED SUSCEPTIBILITY TEST .....	32
8.2.1 TEST SPECIFICATION .....	32
8.2.2 TEST SETUP .....	32
8.2.3 TEST PROCEDURE .....	32
8.2.4 TEST EQUIPMENT LIST AND DETAILS .....	33
8.2.5 PERFORMANCE CRITERION REQUIRED & TEST RESULT .....	33
8.3 ELECTRICAL FAST TRANSIENT/BURST IMMUNITY TEST .....	34
8.3.1 TEST SPECIFICATION .....	34
8.3.2 TEST SETUP .....	34
8.3.3 TEST PROCEDURE .....	35
8.3.4 TEST EQUIPMENT LIST AND DETAILS .....	35
8.3.5 PERFORMANCE CRITERION REQUIRED & TEST RESULT .....	35
8.4 SURGE IMMUNITY TEST .....	36
8.4.1 TEST SPECIFICATION .....	36
8.4.2 TEST SETUP .....	36
8.4.3 TEST PROCEDURE .....	37
8.4.4 TEST EQUIPMENT LIST AND DETAILS .....	37
8.4.5 PERFORMANCE CRITERION REQUIRED & TEST RESULT .....	37
8.5 CONDUCTED SUSCEPTIBILITY TEST .....	38
8.5.1 TEST SPECIFICATION .....	38
8.5.2 TEST SETUP .....	38
8.5.3 TEST PROCEDURE .....	38
8.5.4 TEST EQUIPMENT LIST AND DETAILS .....	39
8.5.5 PERFORMANCE CRITERION REQUIRED & TEST RESULT .....	39
8.6 VOLTAGE DIPS, SHORT INTERRUPTIONS IMMUNITY TESTS .....	40
8.6.1 TEST SPECIFICATION .....	40
8.6.2 TEST SETUP .....	40
8.6.3 TEST PROCEDURE .....	41
8.6.4 TEST EQUIPMENT LIST AND DETAILS .....	41
8.6.5 PERFORMANCE CRITERION REQUIRED & TEST RESULT .....	41
<b>APPENDIX A - EUT PHOTOGRAPHS .....</b>	<b>42</b>
<b>APPENDIX B - TEST SETUP PHOTOGRAPHS .....</b>	<b>49</b>

## Release Record

Report No.	Version	Description	Issued Date
HCT17JR-1604E	Rev.01	Initial Issue	June 12,2017



## 1- GENERAL INFORMATION

### 1.1 Product Description for Equipment under Test (EUT)

#### Client Information

Applicant:	Magnizon Power Systems FZE
Address of applicant:	JAFZA LB11, 1st floor, Office 32, Jebel Ali Free Zone, Dubai- U.A.E, PO Box no: 263819
Manufacturer:	Magnizon Power Systems FZE
Address of Manufacturer:	JAFZA LB11, 1st floor, Office 32, Jebel Ali Free Zone, Dubai- U.A.E, PO Box no: 263819

#### General Description of E.U.T

EUT Name:	HG Series Inverters
Trade Mark:	Magnizon
Model No.:	HG1012-PV, HG1212-PV, HG2024-PV
Test Model No.:	HG1012-PV
Power Supply:	Input: 220-240V 50/60Hz 3.2-6A Output: 230V 50/60Hz 3.2-6A 750W

Remark: \* The test data gathered are from the production sample provided by the manufacturer.  
 \* Supplementary models have the same internal circuit, but only the different output power and current.  
 \* HCT17JR-1604E is produced on the basis of HCT17JR-1603E.

### 1.2 Test Standards

The following Declaration of Conformity report of EUT is prepared in accordance with

EN 62040-2: 2006

EN 61000-3-2: 2014

EN 61000-3-3: 2013

Reference Standards:

EN 61000-4-2: 2009

EN 61000-4-3: 2006+A2:2010

EN 61000-4-4: 2012

EN 61000-4-5: 2014

EN 61000-4-6: 2014

EN 61000-4-8: 2010

EN 61000-4-11: 2004+A1:2017

The objective of the manufacturer is to demonstrate compliance with the described standards above.

### 1.3 Test Summary

Table 1:

Standard	Test Items	Status
EN 62040-2:2006	Conducted Disturbance at The Mains Terminals (150KHz to 30MHz)	<input checked="" type="checkbox"/>
	Conducted Disturbance at The Telecommunication Ports	<input type="checkbox"/>
	Radiated Disturbances (30MHz to 1000MHz)	<input checked="" type="checkbox"/>

Table 2:

Standard	Test Items	Status
EN 61000-3-12	Harmonic Current Test	<input checked="" type="checkbox"/>
EN 61000-3-11	Voltage Fluctuations and Flicker Test	<input checked="" type="checkbox"/>

Table 3:

Standard	Test Items	Status
EN 62040:	Test items as below listed	<input checked="" type="checkbox"/>
EN 61000-4-2	Electrostatic discharge Immunity	<input checked="" type="checkbox"/>
EN 61000-4-3	Radiated Susceptibility (80MHz to 1GHz)	<input checked="" type="checkbox"/>
EN 61000-4-4	Electrical Fast Transient/Burst Immunity	<input checked="" type="checkbox"/>
EN 61000-4-5	Surge Immunity	<input checked="" type="checkbox"/>
EN 61000-4-6	Conducted Susceptibility (150kHz to 80MHz)	<input checked="" type="checkbox"/>
EN 61000-4-8	Power Frequency Magnetic Field Immunity (50/60Hz)	<input type="checkbox"/>
EN 61000-4-11	Voltage Dips, Short Interruptions Immunity	<input checked="" type="checkbox"/>

Note:  Indicates that the test is applicable,  Indicates that the test is not applicable

#### 1.4 Test Methodology

All measurements contained in this report were conducted with CISPR 16-1-1: 2006, radio disturbance and immunity measuring apparatus, and CISPR16-2-3: 2010, Method of measurement of disturbances and immunity.

All measurement required was performed at Shenzhen Hongcai Testing Technology Co., Ltd. at 1st-3rd Floor, Building C, Shuanghuan Xin Yi Dai Hi-Tech Industrial Park, No.8 Baoqing Road, Baolong Industrial Zone, Longgang District, Shenzhen, Guangdong, China

#### 1.5 Test Facility

The test facility is recognized, certified, or accredited by the following organizations:

##### **CNAS - Registration No.: L3923**

Shenzhen Hongcai Testing Technology Co., Ltd. To ISO/IEC 17025:2005 General Requirements for the Competence of Testing and Calibration Laboratories(CNAS-CL01 Accreditation Criteria for the Competence of Testing and Calibration Laboratories) for the competence in the field of testing. The acceptance letter from the CNAS is maintained in our files: Registration: L3923, June 1, 2015.

## 2- SYSTEM TEST CONFIGURATION

### 2.1 Justification

The system was configured for testing in a typical fashion (as normally used by a typical user).

### 2.2 EUT Exercise Software

The EUT exercising program used during radiated and conducted testing was designed to exercise the various system components in a manner similar to a typical use. The software offered by manufacture, can let the EUT being Battery Mode/Line Mode.

### 2.3 Equipment Modifications

The EUT tested was not modified by HCT.

### 2.4 Basic Configuration of Test System

Emission: The equipment under test (EUT) was configured to measure its highest possible radiation level. The test modes were adapted accordingly in reference to the Operating Instructions.

Immunity: The equipment under test (EUT) was configured to the representative operating mode and conditions.

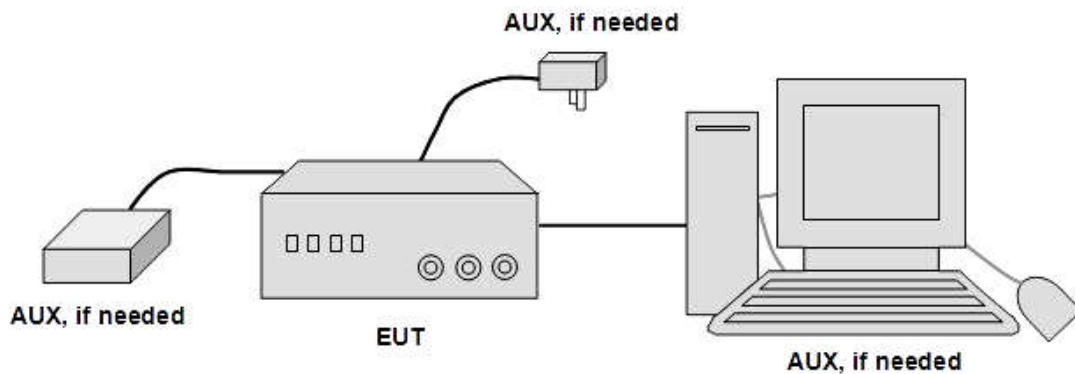



### 3- CONDUCTED DISTURBANCE AT THE MAINS TERMINALS

#### 3.1 Measurement Uncertainty

All measurements involve certain levels of uncertainties, especially in field of EMC. The factors contributing to uncertainties are spectrum analyzer, cable loss, and LISN. The Treatment of Uncertainty in EMC Measurements, the best estimate of the uncertainty of any conducted emissions measurement is  $\pm 3.4$  dB.

#### 3.2 Limit of Conducted Disturbance at The Mains Terminals

Frequency Range (MHz)	Class B Equipment Limits	
	Quasi-Peak (dBuV)	Average (dBuV)
0.150~0.500	66~56	59~46
0.500~5.000	56	46
5.000~30.00	60	50

NOTE 1: The tighter limit shall apply at the edge between two frequency bands.  
 NOTE 2: The limits decrease linearly with the logarithm of the frequency in the range 0.15 MHz to 0.5 MHz.

#### 3.3 EUT Setup

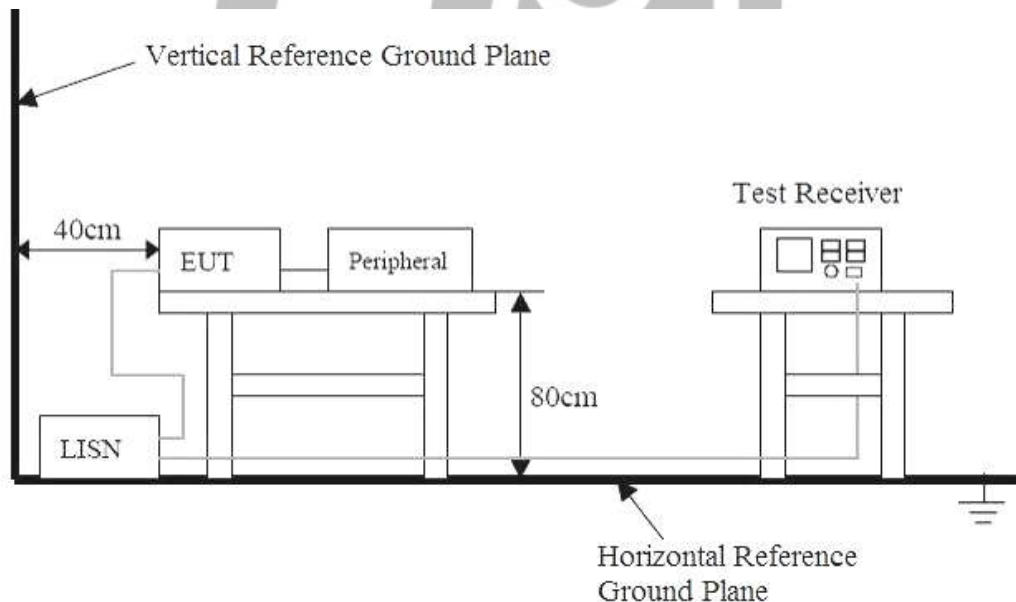

The setup of EUT is according with CISPR 16-1-1: 2006, CISPR16-2-3: 2010 measurement procedure. The specification used was the EN62040-2 limits.

The EUT was placed center and the back edge of the test table.

The AV cables were draped along the test table and bundled to 30-40cm in the middle.

The spacing between the peripherals was 10 cm.

Maximum emission emitted from EUT was determined by manipulating the EUT, support equipment, interconnecting cables and varying the mode of operation and the levels in the final result of the test were recorded with the EUT running in the operating mode that maximum emission was emitted.

### 3.4 Instrument Setup

The test receiver was set with the following configurations:

Test Receiver Setting:

Frequency Range.....	150 KHz to 30 MHz
Detector.....	Peak & Quasi-Peak & Average
Sweep Speed.....	Auto
IF Band Width.....	9 KHz

### 3.5 Test Procedure

1. During the conducted emission test, the EUT power cord was connected to the auxiliary outlet of the first Artificial Mains.
2. Maximizing procedure was performed on the six (6) highest emissions to ensure EUT compliance using all installation combination.
3. All data was recorded in the peak detection mode. Quasi-peak and Average readings were only performed when an emission was found to be marginal (within -10 dB $\mu$ V of specification limits). Quasi-peak readings are distinguished with a "QP". Average readings are distinguished with a "AV".

### 3.6 Test Equipment List and Details

No.	Instrument no.	Equipment	Manufacturer	Model No.	S/N	Last Calculator	Due Calculator
1	HCT-EMC001	EMI Test Receiver	R&S	ESCI	100687	2016-09-01	2017-09-30
2	HCT-EMC020	Teo Line Single Phase Module	SCHWARZBECK	NSLK8128	8128247	2016-09-01	2017-09-30
3	HCT-EMC032	10dB attenuator	ELECTRO-METRICS	EM-7600	836	2016-09-01	2017-09-30

### 3.7 Test Data

Temperature:	22~23 ( °C )
Humidity:	50~54 ( %RH )
Barometric Pressure:	950~1000 ( mbar )
Operating Mode:	Normal Operation
Test Result:	Pass

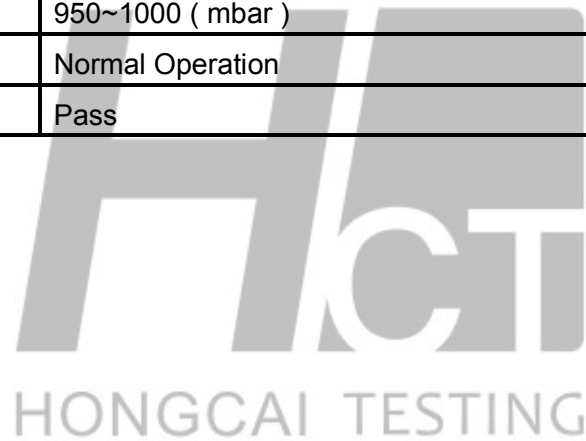

### Conducted Emission Test Data

EUT: HG Series Inverters  
M/N: HG1012-PV  
Operating Condition: Normal Operation  
Test Site: Shielded Room  
Operator: LYM  
Test Specification: AC 230V 50Hz  
Comment: Live Line  
Start of Test: Tem:23°C Hum:50%

**SCAN TABLE: "Voltage (150K-30M) FIN"**  
Short Description: 150K-30M Voltage

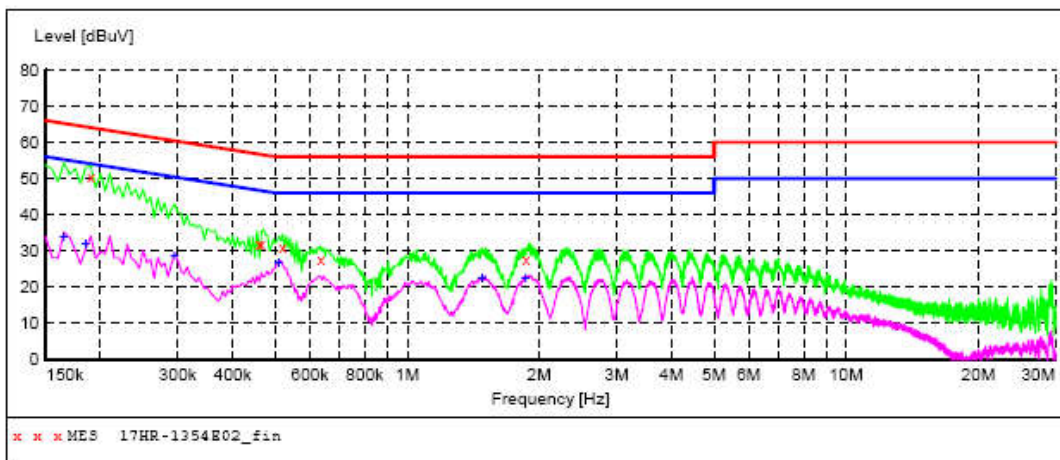

#### MEASUREMENT RESULT: "17HR-1354E02\_fin"

8/30/2017 11:09AM

Frequency MHz	Level dBuV	Transd dB	Limit dBuV	Margin dB	Detector	Line	PE
0.190000	50.40	15.0	64	13.6	QP	L1	GND
0.460000	31.80	10.8	57	24.9	QP	L1	GND
0.465000	31.70	10.8	57	24.9	QP	L1	GND
0.520000	31.00	10.4	56	25.0	QP	L1	GND
0.635000	27.60	10.4	56	28.2	QP	L1	GND
1.865000	27.50	13.0	56	28.5	QP	L1	GND

#### MEASUREMENT RESULT: "17HR-1354E02\_fin2"

8/30/2017 11:09AM

Frequency MHz	Level dBuV	Transd dB	Limit dBuV	Margin dB	Detector	Line	PE
0.165000	33.60	15.3	55	21.6	AV	L1	GND
0.185000	31.90	15.1	54	22.4	AV	L1	GND
0.295000	28.80	11.2	50	21.6	AV	L1	GND
0.510000	26.90	10.4	46	19.1	AV	L1	GND
1.480000	22.60	12.0	46	23.4	AV	L1	GND
1.860000	22.30	13.0	46	23.7	AV	L1	GND

### Conducted Emission Test Data

EUT: HG Series Inverters  
M/N: HG1012-PV  
Operating Condition: Normal Operation  
Test Site: Shielded Room  
Operator: LYM  
Test Specification: AC 230V 50Hz  
Comment: Neutral Line  
Start of Test: Tem:23°C Hum:50%

SCAN TABLE: "Voltage (150K-30M) FIN"  
Short Description: 150K-30M Voltage

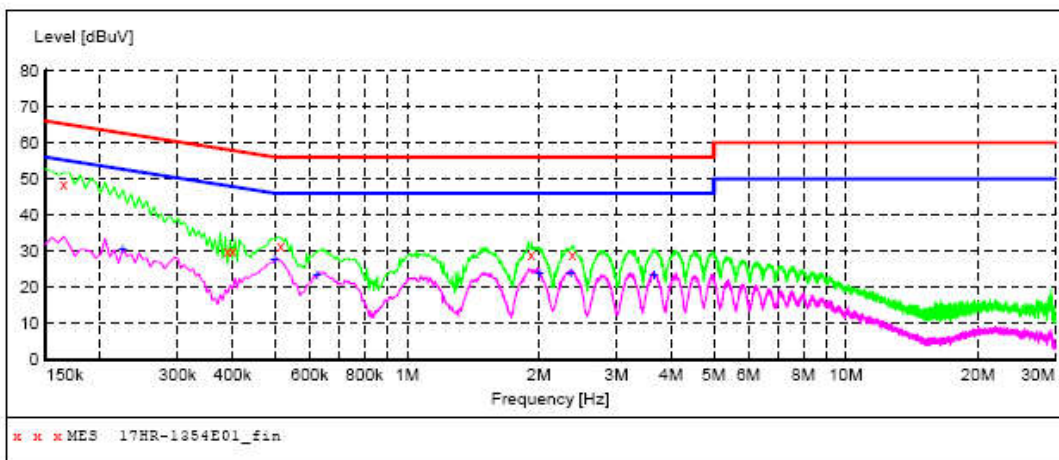

#### MEASUREMENT RESULT: "17HR-1354E01\_fin"

8/30/2017 11:14AM

Frequency MHz	Level dBuV	Transd dB	Limit dBuV	Margin dB	Detector	Line	PE
0.165000	48.60	15.3	65	16.6	QP	N	GND
0.390000	29.90	11.0	58	28.2	QP	N	GND
0.400000	30.10	11.0	58	27.8	QP	N	GND
0.515000	31.60	10.4	56	24.4	QP	N	GND
1.920000	29.10	13.1	56	26.9	QP	N	GND
2.380000	29.00	12.8	56	27.0	QP	N	GND

#### MEASUREMENT RESULT: "17HR-1354E01\_fin2"

8/30/2017 11:14AM

Frequency MHz	Level dBuV	Transd dB	Limit dBuV	Margin dB	Detector	Line	PE
0.225000	30.50	14.4	53	22.1	AV	N	GND
0.500000	27.60	10.4	46	18.4	AV	N	GND
0.625000	23.60	10.4	46	22.4	AV	N	GND
2.005000	24.10	13.3	46	21.9	AV	N	GND
2.360000	23.90	12.9	46	22.1	AV	N	GND
3.655000	23.60	13.0	46	22.4	AV	N	GND

## 4- RADIATED DISTURBANCES

### 4.1 Measurement Uncertainty

All measurements involve certain levels of uncertainties, especially in field of EMC. The factors contributing to uncertainties are spectrum analyzer, cable loss, antenna factor calibration, antenna directivity, antenna factor variation with height, antenna phase center variation, antenna factor frequency interpolation, measurement distance variation, site imperfections, mismatch (average), and system repeatability.

The Treatment of Uncertainty in EMC Measurements, the best estimate of the uncertainty of a radiation emissions measurement is  $\pm 4.0$  dB.

### 4.2 Limit of Radiated Disturbances

Frequency (MHz)	Distance (Meters)	Quasi-Peak (dB $\mu$ V/m)
30 ~ 230	3	40
230 ~ 1000	3	47

NOTE 1: The lower limit shall apply at the transition frequency.  
NOTE 2 : Additional provisions may be required for cases where interference occurs.



### 4.3 EUT Setup

#### Below 1 GHz

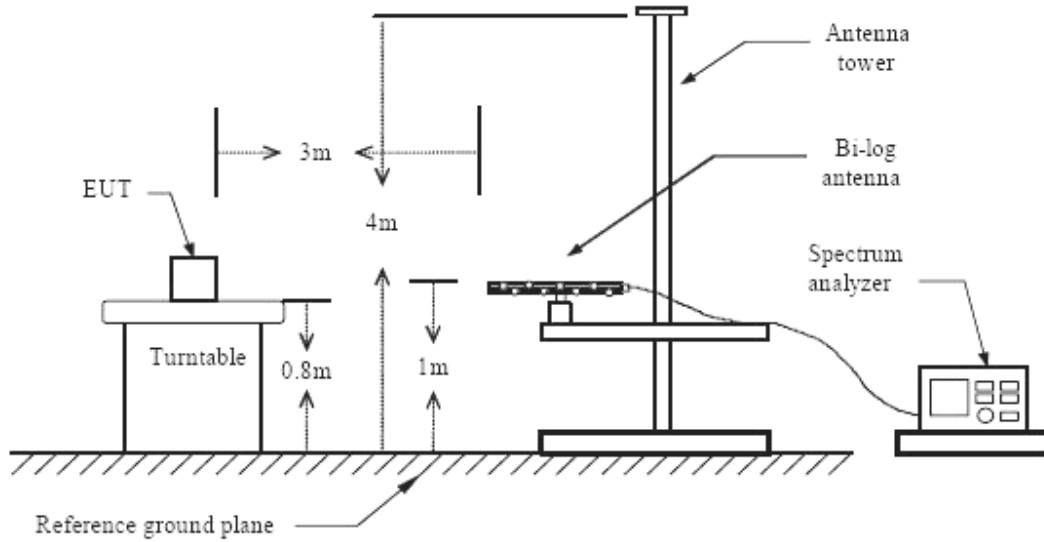

#### Above 1 GHz

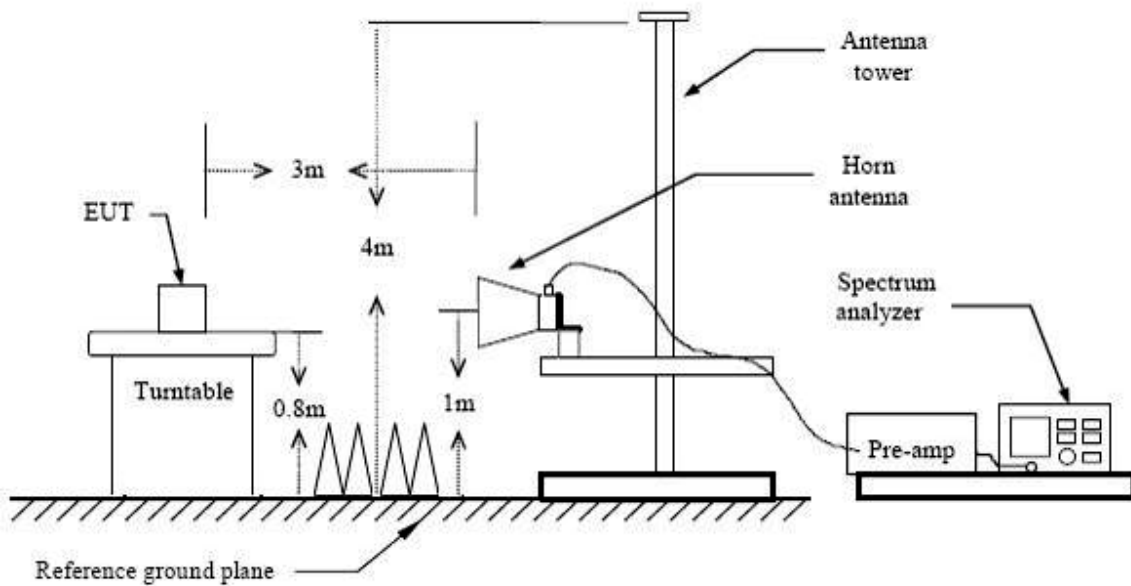

The radiated emission tests were performed in the open area 3-meter test site, using the setup accordance with the CISPR 16-1-1: 2006, CISPR16-2-3: 2010. The specification used was EN62040-2 Class 3 limits.

The EUT was placed on the center of the test table.

Maximum emission emitted from EUT was determined by manipulating the EUT, support equipment, interconnecting cables and varying the mode of operation and the levels in the final result of the test were recorded with the EUT running in the operating mode that maximum emission was emitted.

#### 4.4 Test Receiver Setup

The test receiver was set with the following configurations:

Test Receiver Setting below 1000MHz:

Detector.....Peak & Quasi-Peak  
IF Band Width.....120KHz  
Frequency Range.....30MHz to 1000MHz  
Turntable Rotated.....0 to 360 degrees

Test Receiver Setting above 1000MHz:

Detector.....Peak & Average  
IF Band Width.....1MHz  
Frequency Range.....1000MHz to 6000MHz  
Turntable Rotated.....0 to 360 degrees

Antenna Position:

Height.....1m to 4m  
Polarity.....Horizontal and Vertical

#### 4.5 Test Procedure

1. Maximizing procedure was performed on the highest emissions to ensure that the EUT complied with all installation combinations.
2. All data was recorded in the peak detection mode. Quasi-peak readings performed only when an emission was found to be marginal (within -10 dB $\mu$ V of specification limits), and are distinguished with a "QP" in the data table.

#### 4.6 Corrected Amplitude & Margin Calculation

The Corrected Amplitude is calculated by adding the Antenna Factor and Cable Factor, and subtracting the Amplifier Gain from the Amplitude reading. The basic equation is as follows:

Corr. Ampl. = Indicated Reading + Antenna Factor + Cable Factor - Amplifier Gain

The "Margin" column of the following data tables indicates the degree of compliance with the applicable limit. For example, a margin of 7dB $\mu$ V means the emission is 7dB $\mu$ V below the maximum limit for Class B. The equation for margin calculation is as follows:

Margin = Limit – Corr. Ampl.



#### 4.7 Test Data

Temperature:	22~23 ( °C )
Humidity:	50~54 ( %RH )
Barometric Pressure:	950~1000 ( mbar )
Operating Mode:	Charge
Test Result:	Pass

#### 4.8 Test Equipment List and Details

No.	Instrument no.	Equipment	Manufacturer	Model No.	S/N	Last Calculator	Due Calculator
1	HCT-EMC001	EMI Test Receiver	R&S	ESCI	100687	2016-09-01	2017-09-30
2	HCT-EMC002	EMI Test Receiver	R&S	ESPI	100097	2016-09-01	2017-09-30
3	HCT-EMC018	TRILOG Broadband Test-Antenna	SCHWARZBECK	VULB9163	9163-324	2016-09-01	2017-09-30
4	HCT-EMC019	Horn Antenna	SCHWARZBECK	BBHA9120A	0499	2016-09-01	2017-09-30
5	HCT-EMC037	Broadband preamplifier	SCHWARZBECK	BBV9718	9718-182	2016-09-01	2017-09-30

HONGCAI TESTING

### Radiated Emission Test Data of Below 1GHz

EUT: HG Series Inverters  
 M/N: HG1012-PV  
 Operating Condition: Charge  
 Test Site: CHAMBER  
 Operator: ZHQ  
 Test Specification: AC 230V 50Hz  
 Comment: Polarization: Horizontal  
 Start of Test: Tem:23°C Hum:50%

**SWEEP TABLE: "test (30M-1G)"**

Short Description:		Field Strength				Transducer
Start	Stop	Detector	Meas. Time	IF Bandw.		
Frequency 30.0 MHz	Frequency 1.0 GHz	MaxPeak	Coupled	100 kHz	9163-2015	

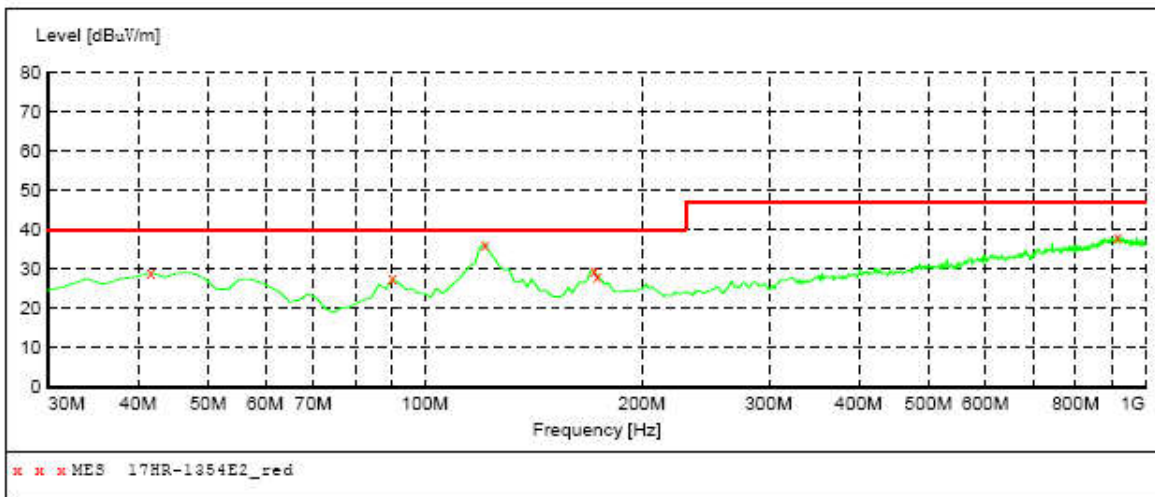

**MEASUREMENT RESULT: "17HR-1354E2\_red"**

8/30/2017 11:30

Frequency MHz	Level dBuV/m	Transd dB	Limit dBuV/m	Margin dB	Det.	Height cm	Azimuth deg	Polarization
41.640000	29.10	15.4	40.0	10.9	QP--	100.0	0.00	HORIZONTAL
90.140000	27.60	15.0	40.0	12.4	QP--	300.0	0.00	HORIZONTAL
121.180000	36.40	13.2	40.0	3.6	QP--	100.0	0.00	HORIZONTAL
171.620000	29.70	12.5	40.0	10.3	QP--	100.0	0.00	HORIZONTAL
173.560000	28.30	12.4	40.0	11.7	QP--	300.0	0.00	HORIZONTAL
914.640000	38.20	25.8	47.0	8.8	QP--	300.0	0.00	HORIZONTAL

### Radiated Emission Test Data of Below 1GHz

EUT: HG Series Inverters  
M/N: HG1012-PV  
Operating Condition: Charge  
Test Site: CHAMBER  
Operator: ZHQ  
Test Specification: AC 230V 50Hz  
Comment: Polarization: Vertical  
Start of Test: Tem:23°C Hum:50%

**SWEEP TABLE: "test (30M-1G)"**

Short Description:		Field Strength				Transducer
Start Frequency	Stop Frequency	Detector	Meas. Time	IF Bandw.		
30.0 MHz	1.0 GHz	MaxPeak	Coupled	100 kHz	9163-2015	

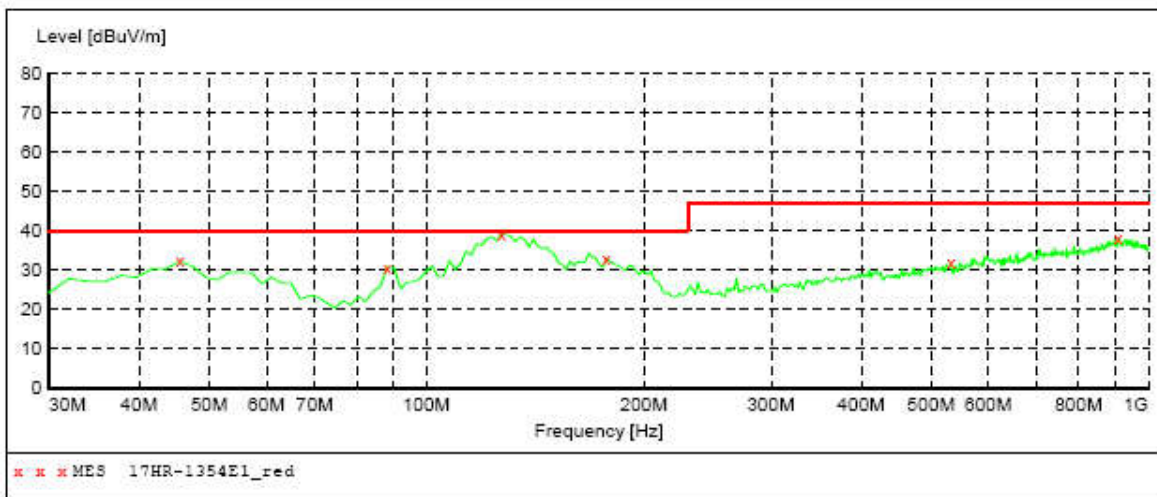

**MEASUREMENT RESULT: "17HR-1354E1\_red"**

8/30/2017 11:33

Frequency MHz	Level dBuV/m	Transd dB	Limit dBuV/m	Margin dB	Det.	Height cm	Azimuth deg	Polarization
45.520000	32.30	16.8	40.0	7.7	QP--	100.0	0.00	VERTICAL
88.200000	30.80	14.1	40.0	9.2	QP--	100.0	0.00	VERTICAL
127.000000	36.90	12.9	40.0	3.1	QP--	100.0	0.00	VERTICAL
177.440000	33.10	12.5	40.0	6.9	QP--	100.0	0.00	VERTICAL
532.460000	32.00	19.6	47.0	15.0	QP--	100.0	0.00	VERTICAL
906.880000	38.00	25.8	47.0	9.0	QP--	100.0	0.00	VERTICAL

## 5- HARMONIC CURRENT TEST

### 5.1 Application of Harmonic Current Emission

Compliance to these standards ensures that tested equipment will not generate harmonic currents at levels that cause unacceptable degradation of the main environment. This directly contributes to meeting compatibility levels established in other EMC standards, which defines compatibility levels for low-frequency conducted disturbances in low-voltage supply systems.

### 5.2 Block Diagram of Test Setup:

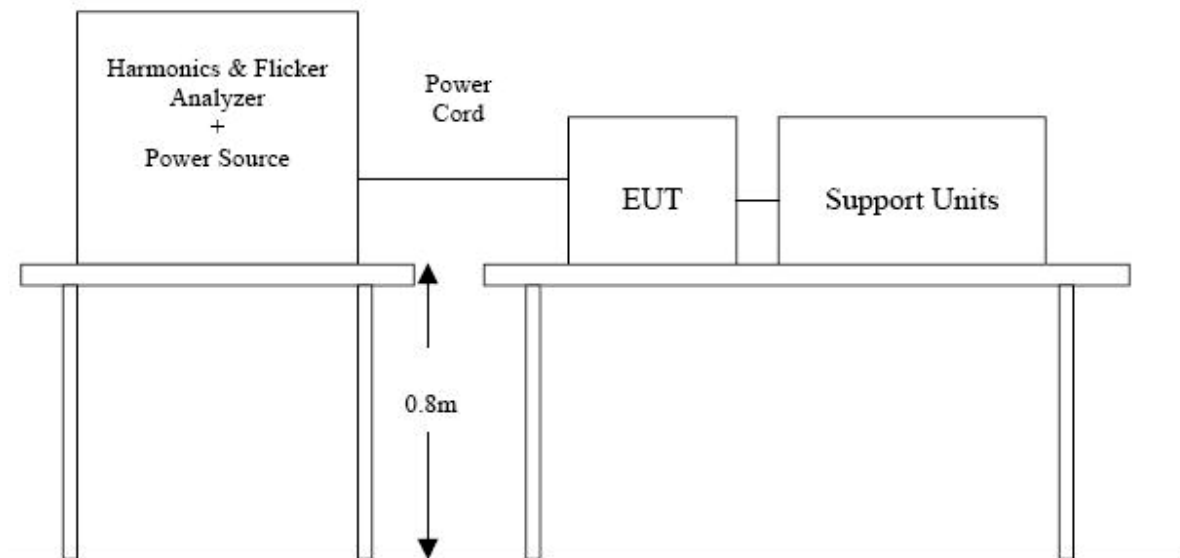

### 5.3 Test Procedure:

1. The EUT was placed on the top of a wooden table 0.8 meters above the ground and operated to produce the maximum harmonic components under normal operating conditions for each successive harmonic component in turn.
2. The correspondent test program of test instrument to measure the current harmonics emanated from EUT is chosen. The measure time shall be not less than the time necessary for the EUT to be exercised.

### 5.4 Test Equipment List and Details

No.	Instrument no.	Equipment	Manufacturer	Model No.	S/N	Last Calculator	Due Calculator
1	HCT-EMC035	HRMONICS&FLICKR E ANALYSER	VOLTECH	PM6000	200006700433	2016-09-01	2017-09-30

### 5.5 Test Result

Basic Standard:	EN/IEC 61000-3-2 Quasi-stationary
Observation time	150s
Windows width:	10 periods - (EN/IEC 61000-4-7 Edition 2000)
Temperature:	22~23 ( °C )
Humidity:	50~54 ( %RH )
Barometric Pressure:	950~1000 ( mbar )
Operating Mode:	Normal Operation
Test Result:	Pass
Note:	The input power of the EUT is less than 75W, then this EUT could be deemed to comply with the requirements of EN61000-3-12 : 2011 without test.

HONGCAI TESTING

<b>Product:</b> 17JR-1603E H <b>Serial no:</b> HG1012-PV <b>Description:</b> ON <b>Test Date:</b> 2017 Oct 18 15:22 <b>Result Name:</b> 17JR-1603E H		2017 Oct 18 15:26 Page 1 of 1
<b>Type of Test:</b> EN61000:2000 Harmonics inc. interharmonics to EN61000-4-7:2002 <b>Limits:</b> Class B <b>Power Analyzer:</b> Voltech PM6000 SN: 200006700433 Firmware version: v1.21.07RC2 <b>Channel(s):</b> 1. SN: 090016500321, 28 Adjusted Date: 8 JAN 2016. 2. SN:None Adjusted Date:None 3. SN:None Adjusted Date:None 4. SN:None Adjusted Date:None 5. SN:None Adjusted Date:None 6. SN:None Adjusted Date:None <b>Shunt(s):</b> 1. SN: 091024301317, 4 Adjusted Date: 8 JAN 2016. 2. SN:None Adjusted Date:None 3. SN:None Adjusted Date:None 4. SN:None Adjusted Date:None 5. SN:None Adjusted Date:None 6. SN:None Adjusted Date:None <b>AC Source:</b> Mains / Manual Source		
<b>Harmonic Results Against Chosen Limits:</b>  <div style="font-size: 2em; color: green; text-align: center;"><b>PASS</b></div>		<b>Notes:</b> Voltage Harmonics outside permitted limits
<b>Test Parameter Details</b>	<b>User Entered</b>	<b>Measured</b>
Operating Frequency:	50	49.9840
Operating Voltage:	230	228.9347
Specified Power:	100.0000	1507.4994
Fundamental Current:	0.7910	6.5808
Power Factor:	0.5026	0.9611
Average Input Current:		6.8413
Maximum POHC:		0.2445
POHC Limit:		0.3771
Maximum THC:		1.8779
Minimum Power:	75	
Class Multiplier:	1.0000	
Test Duration:	00:02:30	

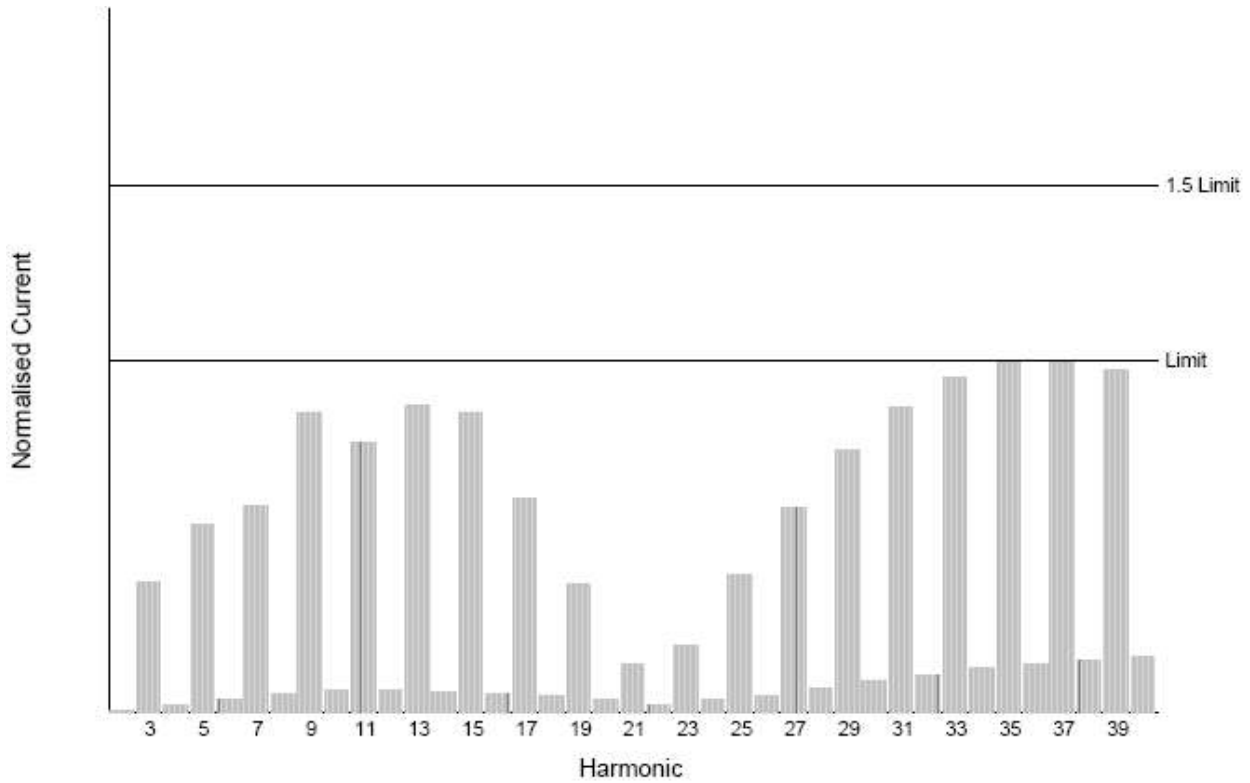

Harm	Limit 1	Limit 2	Average Reading	<L1 <L2	Max Reading	<L2	Pass FAIL	Harm	Limit 1	Limit 2	Average Reading	<L1 <L2	Max Reading	<L2	Pass FAIL
2	1.6200A	2.4300A	11.44mA	N/A	12.60mA	N/A	N/A	3	3.4500A	5.1750A	1.2768A	✓ ✓	1.2781A	✓	Pass
4	645.0mA	967.5mA	13.36mA	N/A	14.63mA	N/A	N/A	5	1.7100A	2.5650A	913.7mA	✓ ✓	914.8mA	✓	Pass
6	450.0mA	675.0mA	16.00mA	N/A	17.17mA	N/A	N/A	7	1.1550A	1.7325A	679.1mA	✓ ✓	680.1mA	✓	Pass
8	345.0mA	517.5mA	16.66mA	N/A	17.80mA	N/A	N/A	9	600.0mA	900.0mA	510.0mA	✓ ✓	510.7mA	✓	Pass
10	276.0mA	414.0mA	15.85mA	N/A	16.90mA	N/A	N/A	11	495.0mA	742.5mA	378.4mA	✓ ✓	379.4mA	✓	Pass
12	230.0mA	345.0mA	13.75mA	N/A	14.61mA	N/A	N/A	13	315.0mA	472.5mA	274.0mA	✓ ✓	275.5mA	✓	Pass
14	197.1mA	295.7mA	11.19mA	N/A	11.92mA	N/A	N/A	15	225.0mA	337.5mA	190.2mA	✓ ✓	191.9mA	✓	Pass
16	172.5mA	258.7mA	9.070mA	N/A	9.592mA	N/A	N/A	17	198.5mA	297.7mA	119.6mA	✓ ✓	121.3mA	✓	Pass
18	153.3mA	230.0mA	6.733mA	N/A	7.100mA	N/A	N/A	19	177.6mA	266.4mA	62.95mA	✓ ✓	64.72mA	✓	Pass
20	138.0mA	207.0mA	4.601mA	N/A	4.952mA	N/A	N/A	21	160.7mA	241.0mA	20.68mA	N/A	22.10mA	N/A	N/A
22	125.4mA	188.1mA	2.650mA	N/A	2.980mA	N/A	N/A	23	146.7mA	220.1mA	26.45mA	N/A	27.79mA	N/A	N/A
24	115.0mA	172.5mA	3.670mA	N/A	4.056mA	N/A	N/A	25	135.0mA	202.5mA	51.53mA	✓ ✓	52.89mA	✓	Pass
26	106.1mA	159.2mA	4.746mA	N/A	5.261mA	N/A	N/A	27	125.0mA	187.5mA	71.52mA	✓ ✓	72.69mA	✓	Pass
28	98.57mA	147.8mA	6.262mA	N/A	6.900mA	N/A	N/A	29	116.3mA	174.5mA	85.66mA	✓ ✓	86.67mA	✓	Pass
30	92.00mA	138.0mA	7.794mA	N/A	8.482mA	N/A	N/A	31	108.8mA	163.3mA	93.93mA	✓ ✓	94.61mA	✓	Pass
32	86.25mA	129.3mA	8.600mA	N/A	9.298mA	N/A	N/A	33	102.2mA	153.4mA	97.09mA	✓ ✓	97.56mA	✓	Pass
34	81.17mA	121.7mA	9.653mA	N/A	10.46mA	N/A	N/A	35	96.42mA	144.6mA	96.34mA	✓ ✓	96.60mA	✓	Pass
36	76.66mA	115.0mA	9.862mA	N/A	10.68mA	N/A	N/A	37	91.21mA	136.8mA	90.88mA	✓ ✓	91.03mA	✓	Pass
38	72.63mA	108.9mA	9.929mA	N/A	10.72mA	N/A	N/A	39	86.53mA	129.8mA	83.91mA	✓ ✓	84.09mA	✓	Pass
40	69.00mA	103.5mA	10.06mA	N/A	10.84mA	N/A	N/A								

<L1 : Reading is below limit 1.

<L2 : Reading is below limit 2.

N/A : Harmonic current below 0.6% of rated current or 5mA, whichever is greater, are disregarded.

	Nominal	Measured	Deviation	Allowed Deviation	Result
Supply Voltage	230.00V	228.93V	1.07V	4.60V	Pass
Supply Frequency	50.00Hz	49.98Hz	0.02Hz	0.25Hz	Pass
Crest Factor	1.4100	1.4200	0.0100	+/- 0.01	Pass

Harmonic	Reading	Limit	Result	Harmonic	Reading	Limit	Result
2	0.19%	0.20%	Pass	3	0.26%	0.90%	Pass
4	0.06%	0.20%	Pass	5	0.32%	0.40%	Pass
6	0.04%	0.20%	Pass	7	0.31%	0.30%	Fail
8	0.04%	0.20%	Pass	9	0.30%	0.20%	Fail
10	0.03%	0.20%	Pass	11	0.27%	0.10%	Fail
12	0.03%	0.10%	Pass	13	0.22%	0.10%	Fail
14	0.02%	0.10%	Pass	15	0.20%	0.10%	Fail
16	0.02%	0.10%	Pass	17	0.13%	0.10%	Fail
18	0.02%	0.10%	Pass	19	0.06%	0.10%	Pass
20	0.01%	0.10%	Pass	21	0.04%	0.10%	Pass
22	0.01%	0.10%	Pass	23	0.04%	0.10%	Pass
24	0.01%	0.10%	Pass	25	0.06%	0.10%	Pass
26	0.01%	0.10%	Pass	27	0.08%	0.10%	Pass
28	0.01%	0.10%	Pass	29	0.13%	0.10%	Fail
30	0.02%	0.10%	Pass	31	0.15%	0.10%	Fail
32	0.02%	0.10%	Pass	33	0.16%	0.10%	Fail
34	0.02%	0.10%	Pass	35	0.16%	0.10%	Fail
36	0.02%	0.10%	Pass	37	0.17%	0.10%	Fail
38	0.02%	0.10%	Pass	39	0.16%	0.10%	Fail
40	0.02%	0.10%	Pass				





## 6- VOLTAGE FLUCTUATIONS AND FLICKER TEST

### 6.1 Application and Limit of Voltage Fluctuations and Flicker Test

Compliance to these standards ensures that tested equipment will not generate flickers and voltage change at levels that cause unacceptable degradation of the main environment. This directly contributes to meeting compatibility levels established in other EMC standards, which defines compatibility levels for low-frequency conducted disturbances in low-voltage supply systems.

Test Item	Limit	Remark
Pst	1.0	Pst means short-term flicker indicator.
Plt	0.65	Plt means long-term flicker indicator.
Tdt (ms)	500	Tdt means maximum time that dt exceeds 3 %.
dmax (%)	4%	dmax means maximum relative voltage change.
dc (%)	3.3%	dc means relative steady-state voltage change

### 6.2 Block Diagram of Test Setup:

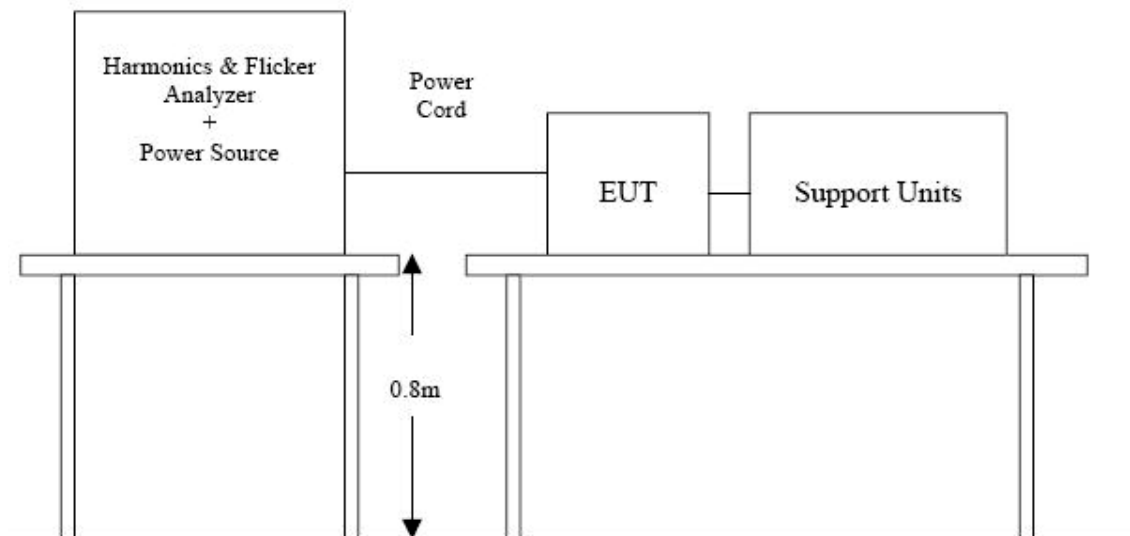

### 6.3 Test Procedure:

1. The EUT was placed on the top of a wooden table 0.8 meters above the ground and operated to produce the most unfavorable sequence of voltage changes under normal operating conditions.
2. During the flick measurement, the measure time shall include that part of whole operation cycle in which the EUT produce the most unfavorable sequence of voltage changes. The observation period for short-term flicker indicator is 10 minutes and the observation period for long-term flicker indicator is 2 hours.

### 6.4 Test Equipment List and Details

No.	Instrument no.	Equipment	Manufacturer	Model No.	S/N	Last Calculator	Due Calculator
1	HCT-EMC035	HRMONICS&FLICKR E ANALYSER	VOLTECH	PM6000	200006700433	2016-09-01	2017-09-30

### 6.5 Test Result

Basic Standard:	EN/IEC 61000-3-3
Short time (Pst)	10 min
Observation time	10 min (1 Flicker measurement)
Temperature:	22~23 ( °C )
Humidity:	50~54 ( %RH )
Barometric Pressure:	950~1000 ( mbar )
Operating Mode:	Normal Operation
Test Result:	Pass

Maximum Flicker results			
Test Item	EUT values	Limit	Result
Pst	0.089	1000	PASS
dc [%]	0.020	3.300	PASS
dmax [%]	0.272	4.000	PASS
dt [s]	0.000	5.00	PASS

## 7- IMMUNITY TEST DESCRIPTION

### 7.1 General Description

Product Standard	EN 62040-2:2006	
Basic Standard, Specification, and Performance Criterion required	EN 61000-4-2	Electrostatic Discharge – ESD: 8kV air discharge, 4kV Contact discharge, Performance Criterion B
	EN 61000-4-3	Radio-Frequency Electromagnetic Field Susceptibility Test – RS: 80 ~ 1000 MHz, 3V/m, 80% AM (1kHz), Performance Criterion A
	EN 61000-4-4	Electrical Fast Transient/Burst - EFT, Power line: 1kV, Signal line: 0.5kV, Performance Criterion B
	EN 61000-4-5	Surge Immunity Test: 1.2/50 us Open Circuit Voltage, 8 /20 us Short Circuit Current, Power Line: line to line 1 kV, line to ground 2 kV Signal line: line to ground: outdoor: 1kV indoor: 0.5kV Performance Criterion B
	EN 61000-4-6	Conducted Radio Frequency Disturbances Test – CS: 0.15 ~ 80 MHz, 3Vrms, 80% AM, 1kHz, Performance Criterion A
	EN 61000-4-11	Voltage Dips: 1) 0% residual for 0.5 cycle, Performance Criterion B 2) 70% residual for 25 cycles, Performance Criterion C Voltage Interruptions: 0% residual for 250 cycles, Performance Criterion B is required for EUT with battery back-up Performance Criterion C is required for EUT without battery back-up

**7.2 The phenomena allowed during and after test in each criterion are clearly stated in the following table**

Performance criteria		
Criteria	During test	After test
A	Shall operate as intended. May show degradation of performance (see note1). Shall be no loss of function. Shall be no unintentional transmissions.	Shall operate as intended. Shall be no degradation of performance (see note 2). Shall be no loss of function. Shall be no loss of stored data or user programmable functions.
B	May show loss of function (one or more). May show degradation of performance (see note 1). No unintentional transmissions.	Functions shall be self-recoverable. Shall operate as intended after recovering. Shall be no degradation of performance (see note 2). Shall be no loss of stored data or user programmable functions.
C	May be loss of function (one or more).	Functions shall be recoverable by the operator. Shall operate as intended after recovering. Shall be no degradation of performance (see note 2).
<p>NOTE 1:            Degradation of performance during the test is understood as a degradation to a level not below a minimum performance level specified by the manufacturer for the use of the apparatus as intended. In some cases the specified minimum performance level may be replaced by a permissible degradation of performance. If the minimum performance level or the permissible performance degradation is not specified by the manufacturer then either of these may be derived from the product description and documentation (including leaflets and advertising) and what the user may reasonably expect from the apparatus if used as intended.</p> <p>NOTE 2:            No degradation of performance after the test is understood as no degradation below a minimum performance level specified by the manufacturer for the use of the apparatus as intended. In some cases the specified minimum performance level may be replaced by a permissible degradation of performance. After the test no change of actual operating data or user retrievable data is allowed. If the minimum performance level or the permissible performance degradation is not specified by the manufacturer then either of these may be derived from the product description and documentation (including leaflets and advertising) and what the user may reasonably expect form the apparatus if used as intended.</p>		

**7.3 Deviations from the standard**

No deviations from EN 62040 were made when performing the tests described in this report.

## 8- IMMUNITY TEST RESULTS

### 8.1 Electrostatic Discharge Immunity Test

#### 8.1.1 Test Specification

Basic Standard:	IEC/EN 61000-4-2
Test Level:	± 2, 4, 8 kV (Air Discharge) ± 2, 4 kV (Contact Discharge) ± 2, 4 kV (Indirect Contact HCP) ± 2, 4 kV (Indirect Contact VCP)
Temperature:	22~23 ( °C )
Humidity:	50~54 ( %RH )
Barometric Pressure:	950~1000 ( mbar )
Operating Mode:	Battery Mode/Line Mode

#### 8.1.2 Test Setup

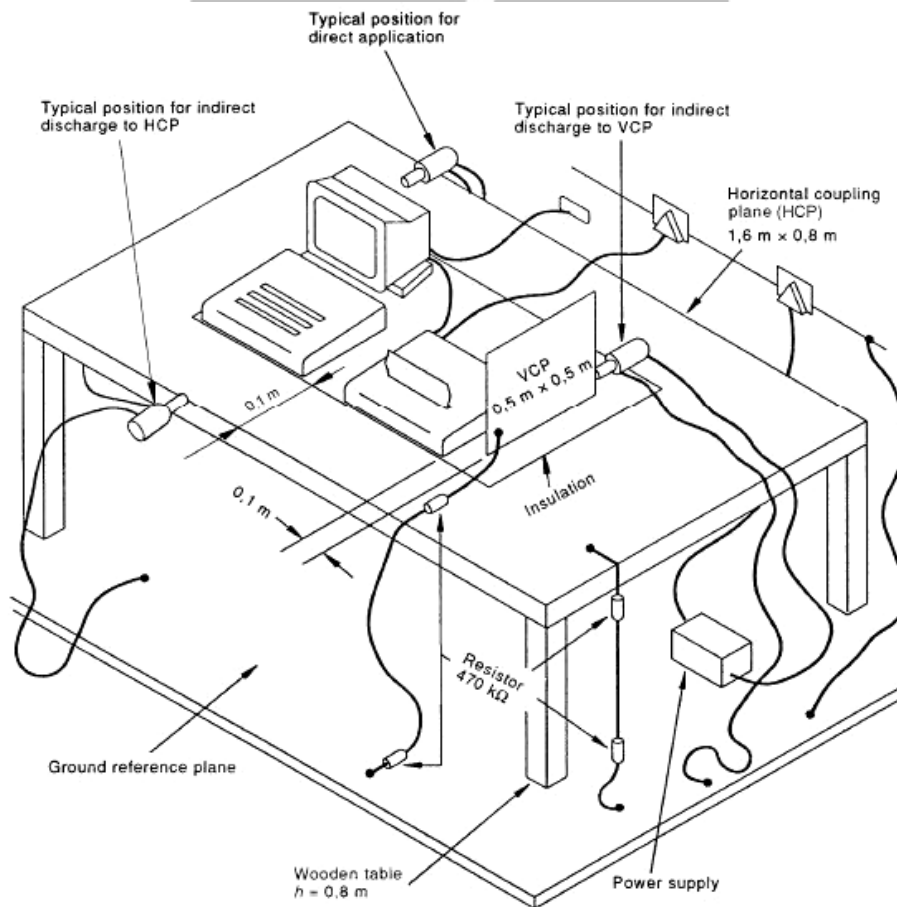

### 8.1.3 Test Procedure

1. Electrostatic discharges were applied only to those points and surfaces of the EUT that are accessible to users during Battery Mode/Line Mode.
2. The test was performed with at least ten single discharges on the pre-selected points in the most sensitive polarity.
3. The time interval between two successive single discharges was at least 1 second.
4. The ESD generator was held perpendicularly to the surface to which the discharge was applied and the return cable was at least 0.2 meters from the EUT.
5. Contact discharges were applied to the non-insulating coating, with the pointed tip of the generator penetrating the coating and contacting the conducting substrate.
6. Air discharges were applied with the round discharge tip of the discharge electrode approaching the EUT as fast as possible (without causing mechanical damage) to touch the EUT. After each discharge, the ESD generator was removed from the EUT and re-triggered for a new single discharge. The test was repeated until all discharges were complete.
7. At least ten single discharges (in the most sensitive polarity) were applied to the Horizontal Coupling Plane at points on each side of the EUT. The ESD generator was positioned horizontally at a distance of 0.1 meters from the EUT with the discharge electrode touching the HCP.
8. At least ten single discharges (in the most sensitive polarity) were applied to the center of one vertical edge of the Vertical Coupling Plane in sufficiently different positions that the four faces of the EUT were completely illuminated. The VCP (dimensions 0.5m x 0.5m) was placed vertically to and 0.1 meters from the EUT.

### 8.1.4 Test Equipment List and Details

No.	Instrument no.	Equipment	Manufacturer	Model No.	S/N	Last Calculator	Due Calculator
1	HCT-EMC008	Electrostatic Discharge Simulator	TESEQ	NSG437	125	2017-09-01	2018-09-30

### 8.1.5 Performance Criterion Required & Test Result

Table 1: Electrostatic Discharge Immunity (Air Discharge)

Test Level			Test Points	Observation Performance	Criterion Required
±2 kV	±4kV	±8kV			
<input checked="" type="checkbox"/>	<input checked="" type="checkbox"/>	<input checked="" type="checkbox"/>	Gap	A	B
<input checked="" type="checkbox"/>	<input checked="" type="checkbox"/>	<input checked="" type="checkbox"/>	Port	A	B
<input checked="" type="checkbox"/>	<input checked="" type="checkbox"/>	<input checked="" type="checkbox"/>	Scerw	A	B
<input checked="" type="checkbox"/>	<input checked="" type="checkbox"/>	<input checked="" type="checkbox"/>	Button	A	B
<input checked="" type="checkbox"/>	<input checked="" type="checkbox"/>	<input checked="" type="checkbox"/>	Other	A	B

Table 2: Electrostatic Discharge Immunity (Direct Contact)

Test Level			Test Points	Observation Performance	Criterion Required
±2 kV	±4kV	±8kV			
<input checked="" type="checkbox"/>	<input checked="" type="checkbox"/>	<input type="checkbox"/>	Other	A	B

Table 3: Electrostatic Discharge Immunity (Indirect Contact HCP)

Test Level			Test Points	Observation Performance	Criterion Required
±2 kV	±4kV	±8kV			
<input checked="" type="checkbox"/>	<input checked="" type="checkbox"/>	<input type="checkbox"/>	Front Side	A	B
<input checked="" type="checkbox"/>	<input checked="" type="checkbox"/>	<input type="checkbox"/>	Back Side	A	B
<input checked="" type="checkbox"/>	<input checked="" type="checkbox"/>	<input type="checkbox"/>	Left Side	A	B
<input checked="" type="checkbox"/>	<input checked="" type="checkbox"/>	<input type="checkbox"/>	Right Side	A	B

Table 4: Electrostatic Discharge Immunity (Indirect Contact VCP)

Test Level			Test Points	Observation Performance	Criterion Required
±2 kV	±4kV	±8kV			
<input checked="" type="checkbox"/>	<input checked="" type="checkbox"/>	<input type="checkbox"/>	Front Side	A	B
<input checked="" type="checkbox"/>	<input checked="" type="checkbox"/>	<input type="checkbox"/>	Back Side	A	B
<input checked="" type="checkbox"/>	<input checked="" type="checkbox"/>	<input type="checkbox"/>	Left Side	A	B
<input checked="" type="checkbox"/>	<input checked="" type="checkbox"/>	<input type="checkbox"/>	Right Side	A	B

Test Result:

## 8.2 Radiated Susceptibility Test

### 8.2.1 Test Specification

Basic Standard:	IEC/EN 61000-4-3
Frequency Range:	80~1000MHz (MHz)
Modulation:	Amplitude 80%, 1kHz sinewave
Test Level:	3V/m
Temperature:	22~23 ( °C )
Humidity:	50~54 ( %RH )
Barometric Pressure:	950~1000 ( mbar )
Operating Mode:	Battery Mode/Line Mode

### 8.2.2 Test Setup

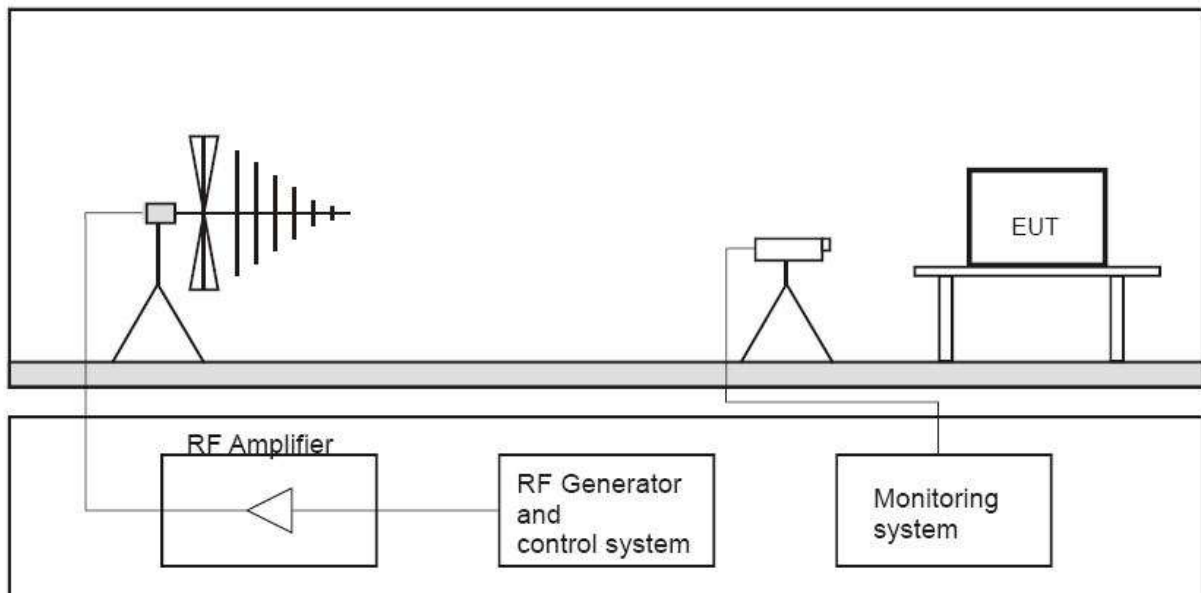

### 8.2.3 Test Procedure

1. The testing was performed in a fully-anechoic chamber.
2. The frequency range is swept from 80 MHz to 1000 MHz, with the signal 80% amplitude modulated with a 1kHz sine wave.
3. The dwell time at each frequency shall not be less than the time necessary for the EUT to be exercised and to respond, but shall in no case be less than 0,5s.
4. The field strength level was 3V/m.
5. The test was performed with the EUT exposed to both vertically and horizontally polarized fields on each of the four sides.



### 8.2.4 Test Equipment List and Details

No.	Equipment	Manufacturer	Model No.	S/N	Calibration Date	Next Calibration Date
1	3M Chamber & Accessory Equipment	ETS-LINDGREN	FACT-3	3510	2017-09-01	2018-09-30
2	ESG Vector signal generators	Agilent	E4438C	MY45095744	2017-09-01	2018-09-30
3	Power Amplifier	AR	150W1000	0322288	2017-09-01	2018-09-30
4	Power Amplifier	AR	25S1G4A	0321112	2017-09-01	2018-09-30
5	TRILOG Broadband Antenna	schwarzbeck	VULB 9136	401	2017-09-01	2018-09-30
6	Horn Antenna	ETS-LINGREN	3117	00057407	2017-09-01	2018-09-30
7	3M Chamber & Accessory Equipment	ETS-LINDGREN	FACT-3	3510	2017-09-01	2018-09-30
8	Spectrum Analyzer	Agilent	E4440A	MY46185649	2017-09-01	2018-09-30
9	TRILOG Broadband Antenna	schwarzbeck	VULB 9136	401	2017-09-01	2018-09-30
10	Multi device Controller	ETS-LINGREN	2090	00057230	N/A	N/A
11	Horn Antenna	ETS-LINGREN	3117	00057407	2017-09-01	2018-09-30
12	Microwave Preamplifier	Agilent	8449B	3008A02425	2017-09-01	2018-09-30

### 8.2.5 Performance Criterion Required & Test Result

Frequency Band (MHz)	Test Level	Test Points	Observation Performance	Criterion Required
80-1000	3V/m	Front Side	A	A
80-1000	3V/m	Rear Side	A	A
80-1000	3V/m	Left Side	A	A
80-1000	3V/m	Right Side	A	A

Test Result: Pass

### 8.3 Electrical Fast Transient/Burst Immunity Test

#### 8.3.1 Test Specification

Basic Standard :	IEC/EN 61000-4-4
Test Level:	± 1 kV for AC Power Line ± 0.5 kV for signal ports (If applicable)
Impulse Frequency:	5kHz
Impulse Wave-shape:	5/50ns
Burst Duration:	15ms
Burst Period:	300ms
Test Duration:	1 min.
Temperature:	22~23 ( °C )
Humidity:	50~54 ( %RH )
Barometric Pressure:	950~1000 ( mbar )
Operating Mode:	Normal Operation

#### 8.3.2 Test Setup

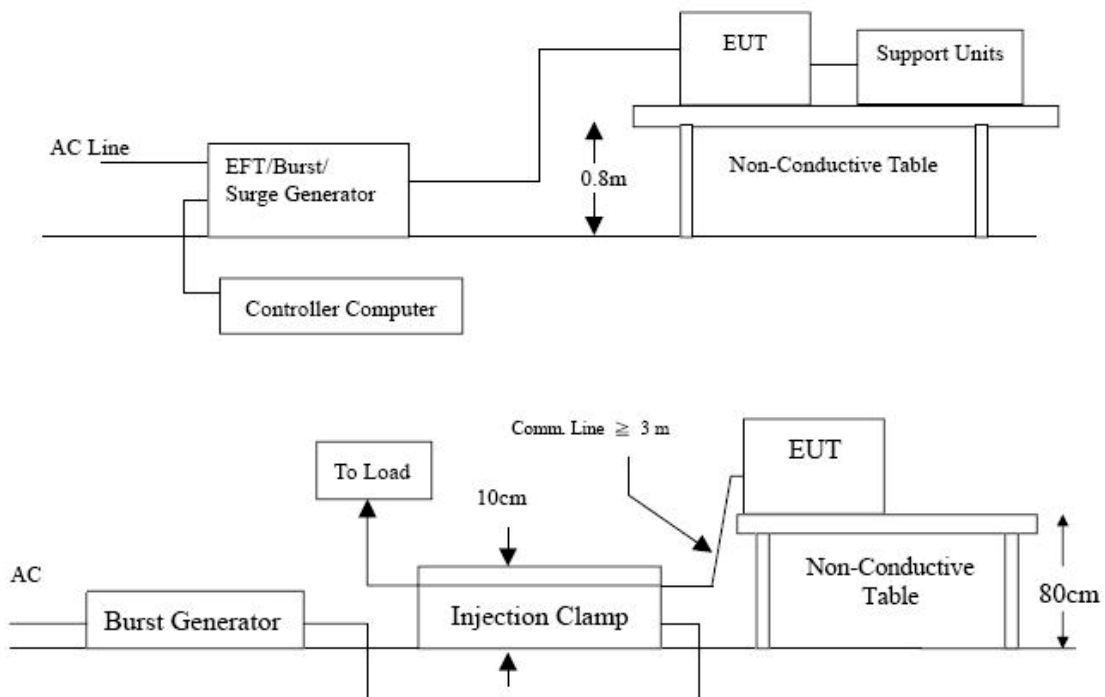

### 8.3.3 Test Procedure

1. Both positive and negative polarity discharges were applied.
2. The length of the “hot wire” from the coaxial output of the EFT generator to the terminals on the EUT should be 0.5m.
3. The duration time of each test sequential was 1 minute.
4. The transient/burst waveform was in accordance with EN 61000-4-4, 5/50ns.

### 8.3.4 Test Equipment List and Details

No.	Instrument no.	Equipment	Manufacturer	Model No.	S/N	Last Calculator	Due Calculator
1	HCT-EMC009	Fast Transient Burst Generator	SCHAFFNER	MODULA6150	34572	2017-09-01	2018-09-30

### 8.3.5 Performance Criterion Required & Test Result

Voltage	Test Points	Observation Performance	Criterion Required
±2kV	L	A	B
±2kV	N	A	B
±2kV	Earth	/	/
±2kV	L+N	A	B
±2kV	L + Earth	/	/
±2kV	N + Earth	/	/
±2kV	L+N+Earth	/	/
±0.5kV	Control Line	/	/
±0.5kV	DSL (RJ11)	/	/
±0.5kV	LAN (RJ45)	/	/

Test Result: Pass

## 8.4 Surge Immunity Test

### 8.4.1 Test Specification

Basic Standard :	IEC/EN 61000-4-5
Test Level:	± 0.5, 1 kV (Line to Line) for AC Power Line ±0.5, 1, 2 kV (Line(s) to Ground) for AC Power Line ± 0.5 kV for unshielded unsymmetrically operated interconnection lines (If applicable)
Wave-Shape:	Combination Wave 1.2/50 us Open Circuit Voltage 8/20 us Short Circuit Current
Generator Impedance:	42 ohm between signal line and ground 2 ohm between networks
Phase Angle:	0° /90°/180°/270°
Pulse Repetition Rate:	1 time / min
Number of Tests:	5 positive and 5 negative at selected points
Temperature:	22~23 ( °C )
Humidity:	50~54 ( %RH )
Barometric Pressure:	950~1000 ( mbar )
Operating Mode:	Normal Operation

### 8.4.2 Test Setup

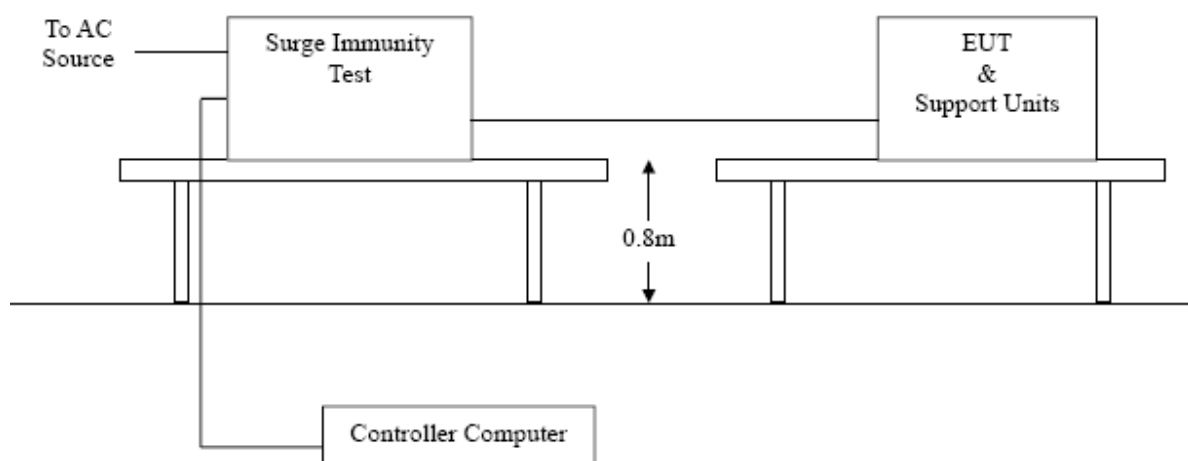

### 8.4.3 Test Procedure

1. For EUT power supply:

The surge is applied to the EUT power supply terminals via the capacitive coupling network. Decoupling networks are required in order to avoid possible adverse effects on equipment not under test that may be powered by the same lines, and to provide sufficient decoupling impedance to the surge wave. The power cord between the EUT and the coupling/decoupling networks was shorter than 2 meters in length.

2. For test applied to unshielded unsymmetrically operated interconnection lines of EUT: (If applicable)

The surge was applied to the lines via the capacitive coupling. The coupling / decoupling networks didn't influence the specified functional conditions of the EUT. The interconnection line between the EUT and the coupling/decoupling networks was shorter than 2 meters in length.

### 8.4.4 Test Equipment List and Details

No.	Instrument no.	Equipment	Manufacturer	Model No.	S/N	Last Calculator	Due Calculator
1	HCT-EMC009	Fast Transient Burst Generator	SCHAFFNER	MODULA6150	34572	2017-09-01	2018-09-30

### 8.4.5 Performance Criterion Required & Test Result

Voltage	Test Points	Observation Performance	Criterion Required
±0.5kV	L-N	A	B
±1kV	L-N	A	B
±2kV	L-PE, N-PE	/	/
±4kV	L-N, L-PE, N-PE	/	/
±0.5kV	Control Line	/	/
±0.5kV	DSL (RJ11)	/	/
±0.5kV	LAN (RJ45)	/	/

Test Result: Pass

## 8.5 Conducted Susceptibility Test

### 8.5.1 Test Specification

Basic Standard:	IEC/EN 61000-4-6
Test Level:	3Vr.m.s
Frequency Range:	0.15~80MHz (MHz)
Modulation:	Amplitude 80%, 1kHz sinewave
Frequency Step:	1 % of preceding frequency value
Temperature:	22~23 ( °C )
Humidity:	50~54 ( %RH )
Barometric Pressure:	950~1000 ( mbar )
Operating Mode:	Normal Operation

### 8.5.2 Test Setup

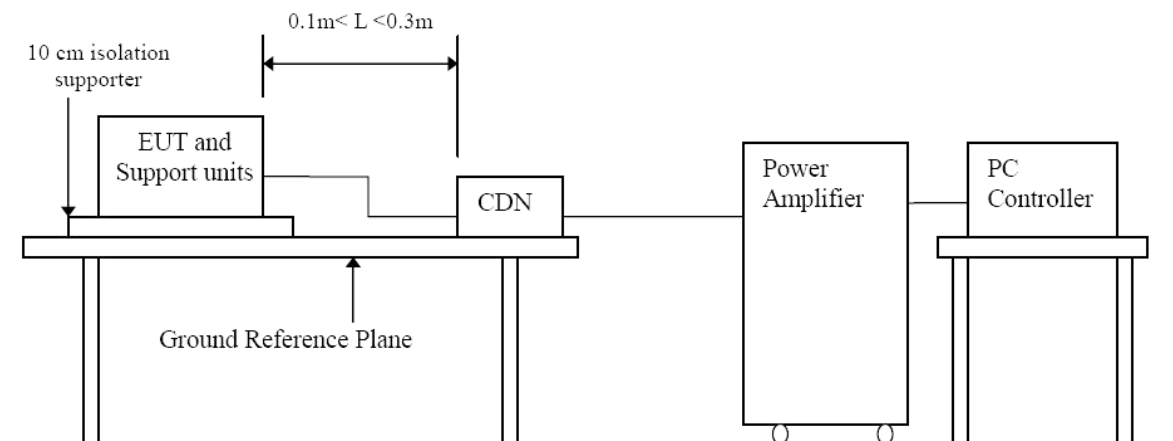

### 8.5.3 Test Procedure

1. The test was performed with the test generator connected to each of the coupling and decoupling devices in turn, while the other non-excited RF input ports of the coupling devices are terminated by a 50-ohm load resistor.
2. The frequency range was swept from 150 kHz to 80 MHz, using the signal level established during the setting process and with a disturbance signal of 80 % amplitude. The signal was modulated with a 1 kHz sine wave, pausing to adjust the RF signal level or the switch coupling devices as necessary. The sweep rate was  $1.5 \times 10^{-3}$  decades/s. Where the frequency range is swept incrementally, the step size was 1 % of preceding frequency value from 150 kHz to 80 MHz.

3. The dwell time at each frequency was less than the time necessary for the EUT to be exercised, and able to respond. Sensitive frequencies such as clock frequency(ies) and harmonics or frequencies of dominant interest, was analyzed separately.
4. Attempts was made to fully exercise the EUT during testing, and to fully interrogate all exercise modes selected for susceptibility.

#### 8.5.4 Test Equipment List and Details

No.	Instrument no.	Equipment	Manufacturer	Model No.	S/N	Last Calculator	Due Calculator
1	HCT-EMC026	RF POWER AMPLIFIER	FRANKONIA	FLL-75	1020A1109	2017-09-01	2018-09-30
2	HCT-EMC027	CDN	FRANKONIA	CDN M2+M3	A3027019	2017-09-01	2018-09-30
3	HCT-EMC029	6DB Attenuator	FRANKONIA	75-A-FFN-06	1001698	2017-09-01	2018-09-30
4	HCT-EMC030	EM Injection clamp	FCC	F-203I-23mm	091536	2017-09-01	2018-09-30

#### 8.5.5 Performance Criterion Required & Test Result

Frequency Band (MHz)	Voltage (Vrms)	Test Points	Observation Performance	Criterion Required
0.15-80	3	L-N	A	B

Test Result: Pass

## 8.6 Voltage Dips, Short Interruptions Immunity Tests

### 8.6.1 Test Specification

Basic Standard:	IEC/EN 61000-4-11
Test Level:	Voltage Dips: 1) 0% residual voltage for 0.5 cycle, 2) 70% residual voltage for 25 cycles, Voltage Interruptions: 0% residual voltage for 250 cycles
Interval between event:	10 seconds
Phase Angle:	0°/180°
Test cycle:	3 times
Temperature:	22~23 ( °C )
Humidity:	50~54 ( %RH )
Barometric Pressure:	950~1000 ( mbar )
Operating Mode:	Normal Operation

### 8.6.2 Test Setup

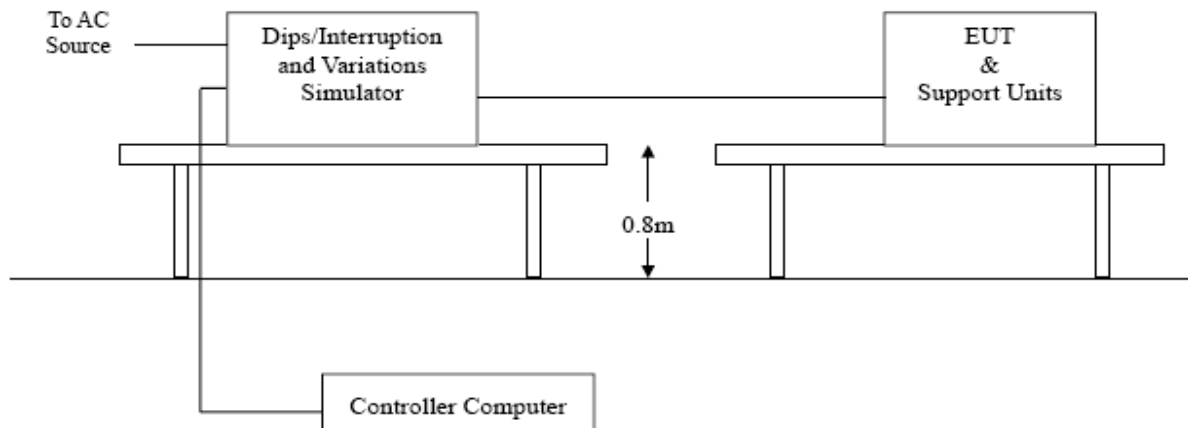



### 8.6.3 Test Procedure

The EUT was tested for each selected combination of test levels and duration with a sequence of 3 dips/interruptions with intervals of 10s (between each test event). Each representative mode of operation shall be tested. Abrupt changes in supply voltage shall occur at zero crossings of the voltage waveform.

### 8.6.4 Test Equipment List and Details

No.	Instrument no.	Equipment	Manufacturer	Model No.	S/N	Last Calculator	Due Calculator
1	BCT-EMC009	Fast Transient Burst Generator	SCHAFFNER	MODULA6150	34572	2017-09-01	2018-09-30

### 8.6.5 Performance Criterion Required & Test Result

Ut: 230V AC, 50Hz			
Voltage (% Residual)	Duration (Period)	Observation Performance	Criterion Required
0	0.5	A	B
70	25	B	C
0	250	C	C

Test Result: Pass

**APPENDIX A - EUT PHOTOGRAPHS**

<p>EUT view</p> <p><input checked="" type="checkbox"/> Whole</p> <p><input type="checkbox"/> Rear</p> <p><input type="checkbox"/> Right</p> <p><input type="checkbox"/> Left</p> <p><input type="checkbox"/> Top</p> <p><input type="checkbox"/> Bottom</p>	
---	--

<p>EUT view</p> <p><input checked="" type="checkbox"/> Front</p> <p><input type="checkbox"/> Rear</p> <p><input type="checkbox"/> Right</p> <p><input type="checkbox"/> Left</p> <p><input type="checkbox"/> Top</p> <p><input type="checkbox"/> Bottom</p>	
---	--



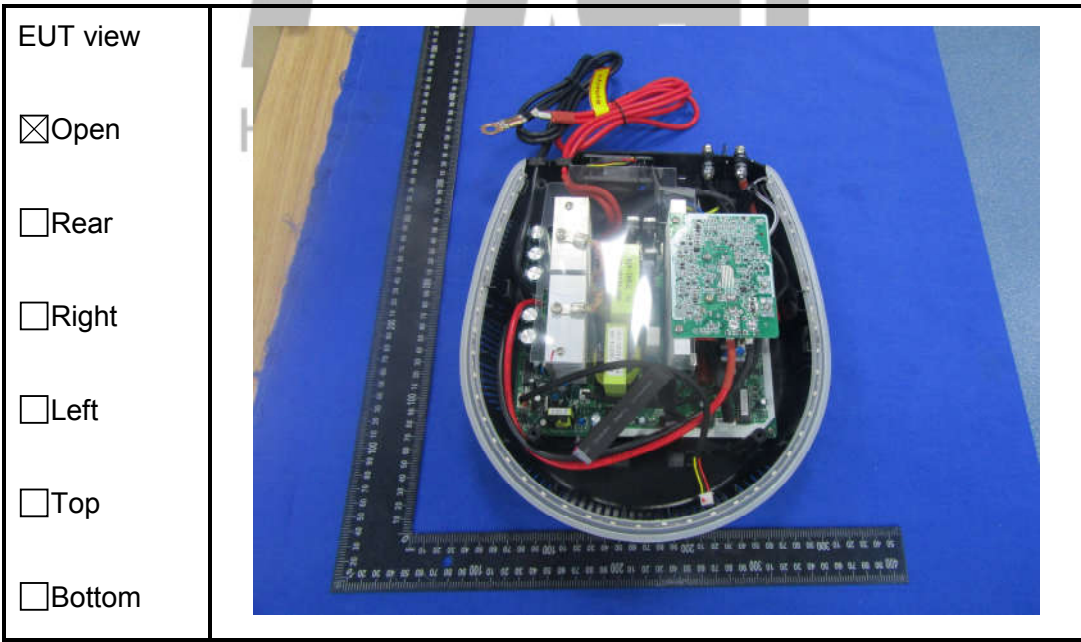

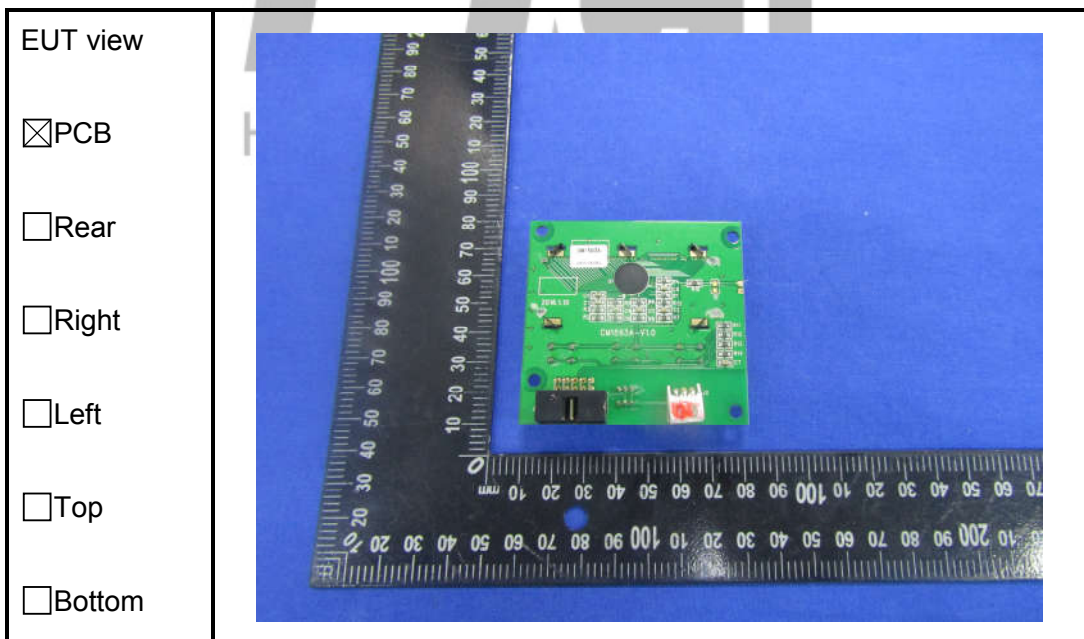

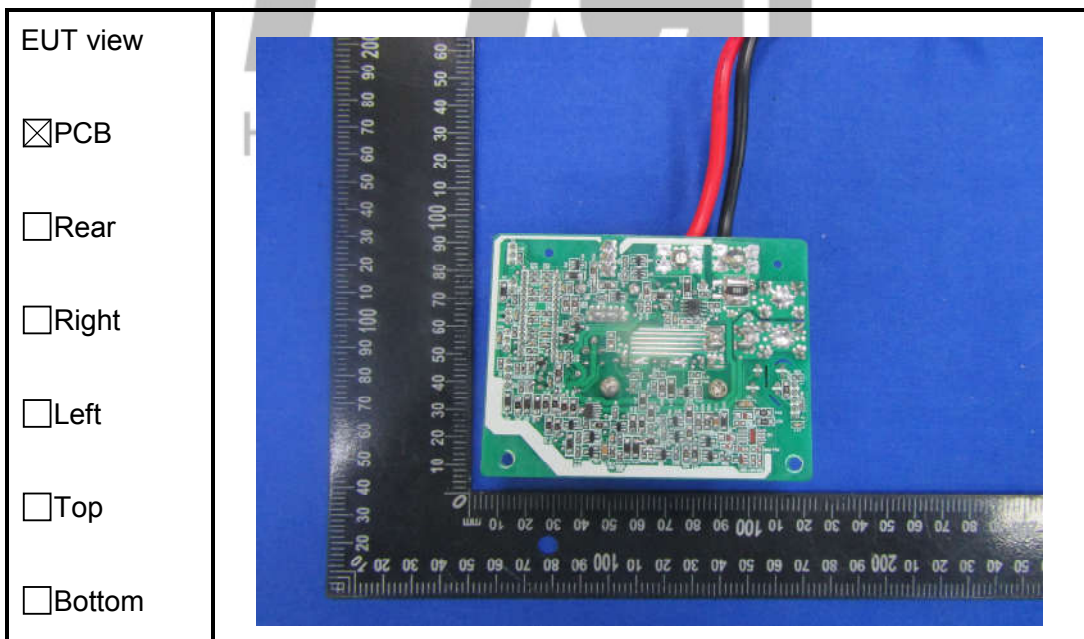
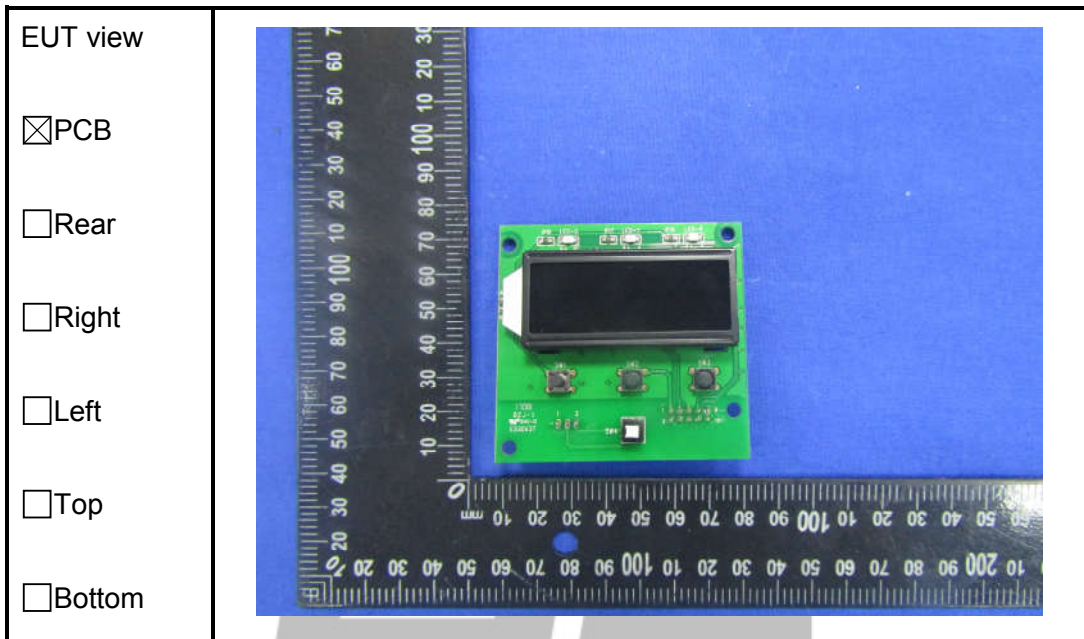

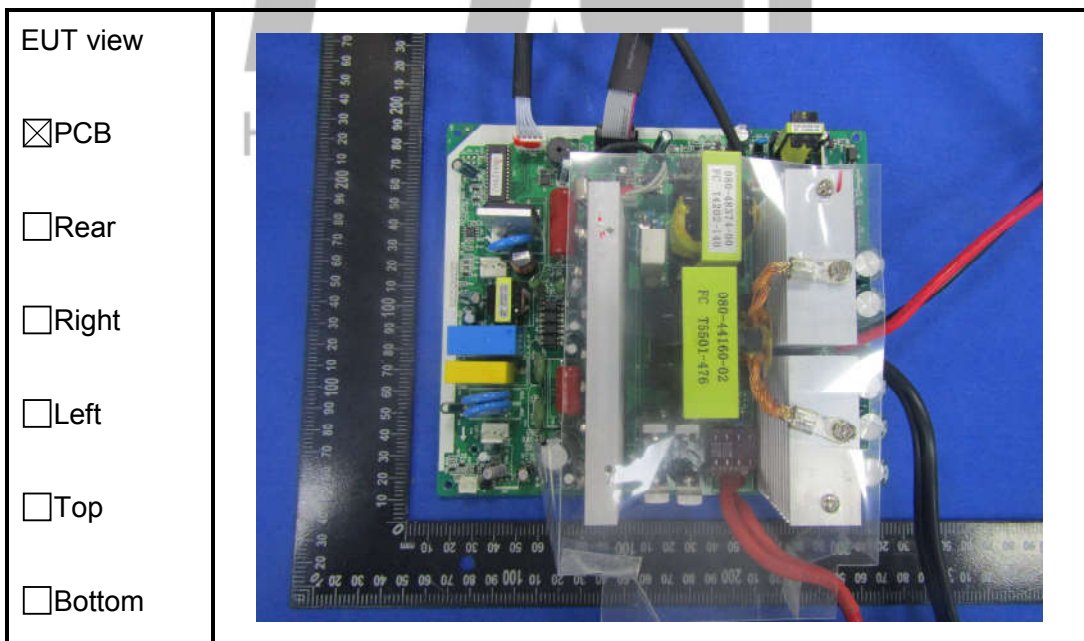
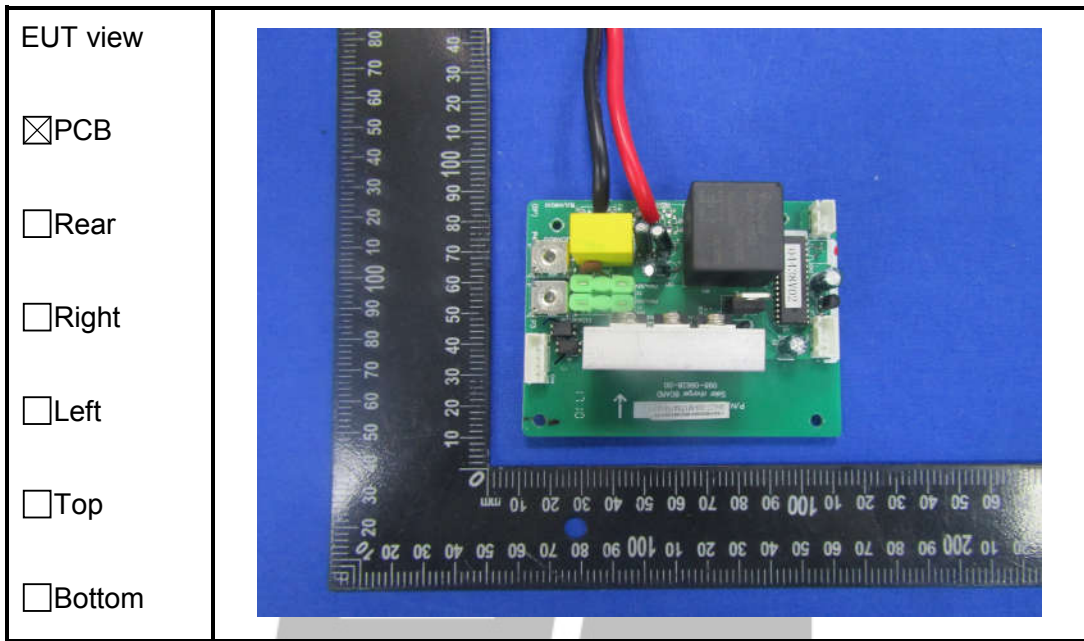

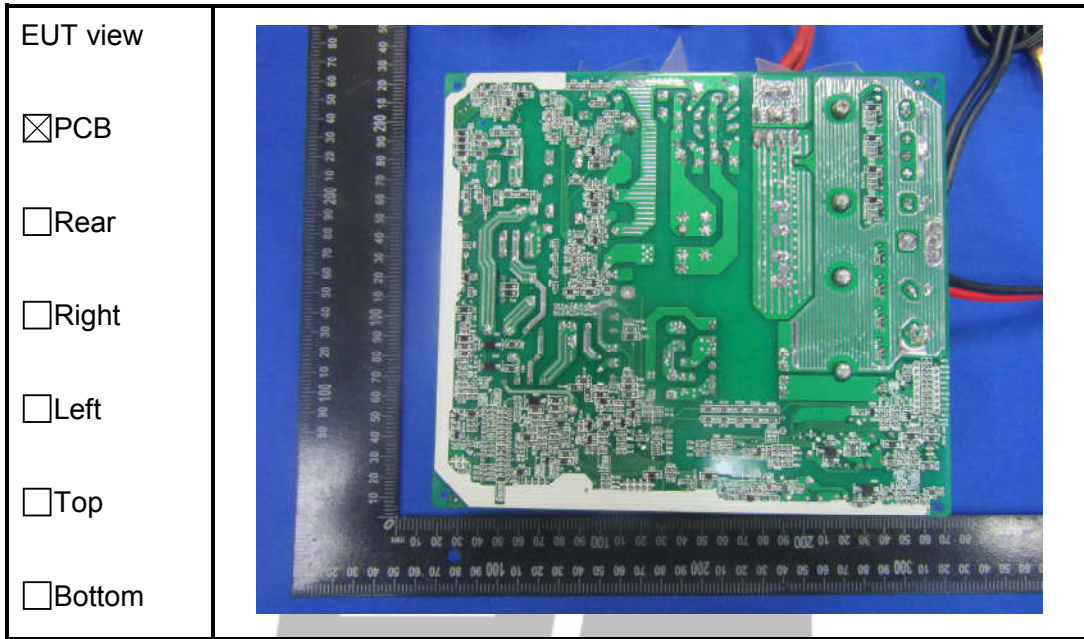



## APPENDIX B - TEST SETUP PHOTOGRAPHS

### Conducted Disturbance at The Mains Terminals

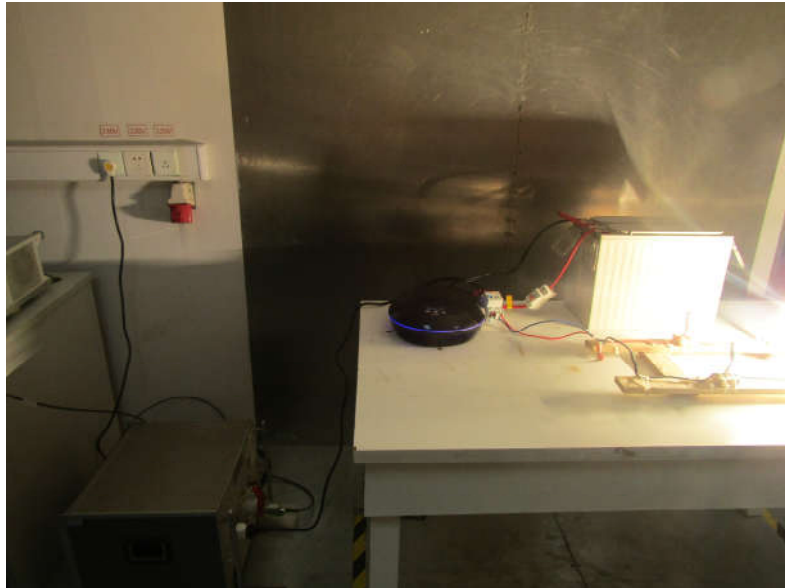

### Radiated Emission

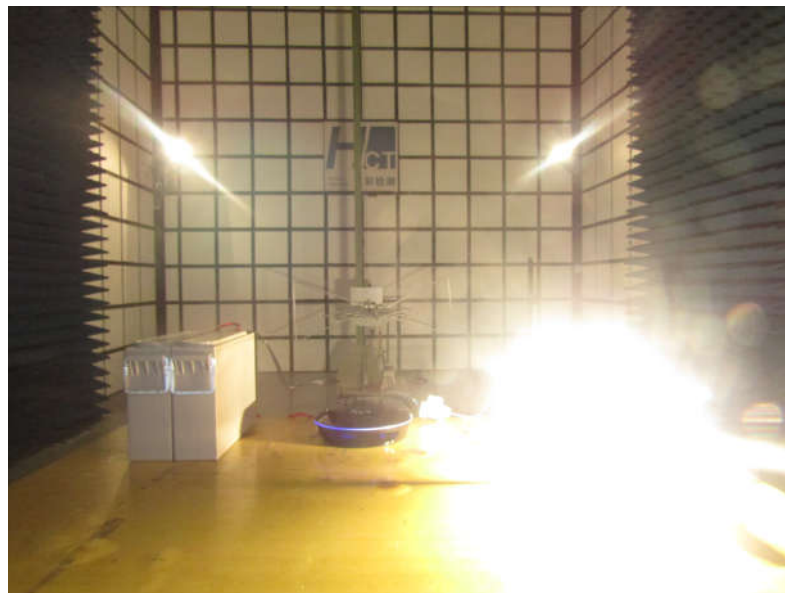

### Harmonic Current Test / Voltage Fluctuations And Flicker Test



### Radiated Susceptibility

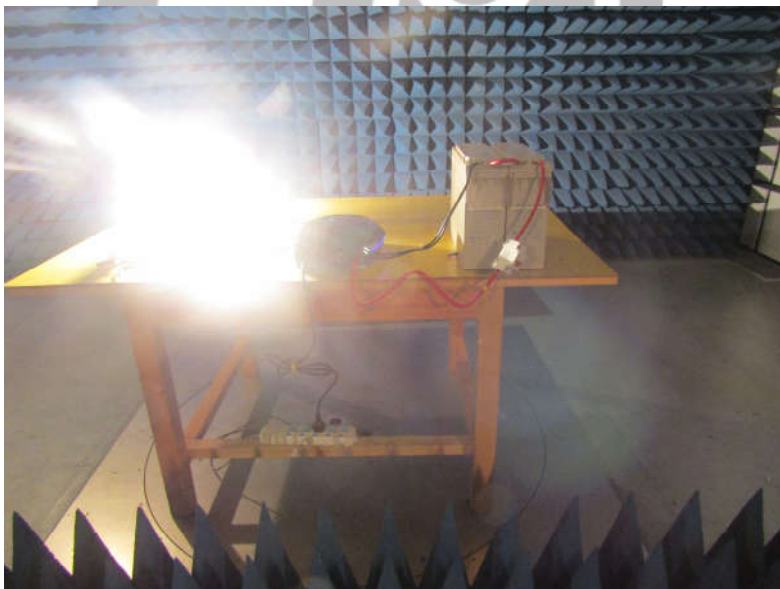

### Electrostatic Discharge Immunity Test



### Electrical Fast Transient / Surge / Voltage Dips, Short Interruptions Immunity Test

